

Tectus

User Guide

TEC-L, TEC-R

EN	User Guide	2
DE	Bedienungsanleitung	32
NO	Brukerhåndbok	62

Contents



Contents	2
1 Description and Intended Purpose	3
2 Safety Information	4
3 Construction	6
4 Key Points.....	8
5 Maintenance.....	8
5.1 Critical Service Indicator.....	9
5.2 Hard Reset.....	10
5.3 Cleaning	10
5.4 Replacing the Key Fob Battery	10
6 Limitations on Use	11
7 Battery Charging	12
7.1 Battery Charging Safety Information.....	12
7.2 Before Charging.....	13
7.3 On-Screen Battery Level Indicator.....	13
7.4 Connecting and Disconnecting the Charger.....	14
7.5 Battery Charger LED Indications.....	15
7.6 Charging and Operating Reference Times.....	15
8 How to Don and Doff the Tectus KAFO.....	16
8.1 Donning the Tectus KAFO.....	16
8.2 Doffing the Tectus KAFO	17
9 Turning the Device ON/OFF	18
10 Tectus Knee Module Operation	20
10.1 User Modes.....	20
10.2 Safety While Switching Between User Modes	20
10.3 Activities and Associated User Modes.....	22
10.4 Operating Actions and Device Indications	26
10.5 Mode Switching on the Device Using Tectus Module Buttons A and/or B	27
10.6 Mode Switching on the Device Using The Key Fob	28
10.7 Additional Key Fob Functions.....	28
10.8 Mechanical Override Operation	29
11 Transport and Storage.....	29



Please read all safety warnings in Section 2 and 7 before setting up or using the device.

1 Description and Intended Purpose

These instructions are for the user (wearer) only.

The term device is used throughout these instructions for use to refer to Tectus, a knee system comprising Tectus knee module, follower joint, battery pack, side-bars and associated key fob controllers. The terms Tectus KAFO (Knee-Ankle-Foot Orthosis) or brace are used throughout these instructions for use to refer to a custom-made full leg orthosis incorporating the device and manufactured to a practitioner's prescription.

Note... The ankle joint is not manufactured by Blatchford and not covered by these instructions for use. Refer to manufacturer's documentation.

The term *programming device* is used throughout these instructions for use to refer to a tablet or mobile phone running an Android or iOS operating system.

The term *app* is used throughout these instructions for use to refer to the Tectus programming application which resides on the programming device.

Make sure that you understand all instructions for use, drawing particular attention to all maintenance and safety information sections.

Application

This device is to be used exclusively as part of a lower limb orthosis.

Intended for a single user.

This device is a Class I CE marked medical device according to the Medical Device Regulation 2017/745 that is for use as a component of a lower limb orthosis. The brace is a custom-made medical device. The device, when assembled as part of a KAFO, is a microprocessor-controlled swing and stance device allowing automatic adjustment of flexion resistance and manual adjustment of extension resistance.

The device allows you to undertake activities such as walking, standing, sitting and descending stairs. You can control the device by switching it between different operating modes for different activities, using control buttons on the device and/or control buttons on a key fob. The practitioner can also use these controls in conjunction with the app to customise device operation to suit your requirements.

2 Safety Information



This warning symbol highlights important safety information which must be followed carefully.



Contact your practitioner if your condition changes.



Regularly check the limb on which the Tectus KAFO is worn for signs of skin irritation, tissue damage, pressure sores or discomfort and report any such signs to your practitioner.



Assembly, programming, maintenance and repair of the device (including handling and replacement of the battery unit) must only be carried out by a suitably qualified practitioner or technician that has attended an approved training course.



Be aware of finger trap hazards at all times.



Do not place near any heat source. Do not leave in direct sunshine or inside a car in hot weather.



Avoid strong magnetic fields, radioactive environments, sources of electrical interference, atmospheres containing liquids and/or powders.



Do not wear the device during any scanning procedures (e.g. X-ray, CT or MRI scan).



The device is not intended for use when immersed in water or as a shower orthosis. If the orthosis comes into contact with water remove and dry immediately.



Any excessive changes in heel height after programming will adversely affect the function of the orthosis. Only footwear approved by the practitioner should be used with the orthosis.



Advise your practitioner if you use a pacemaker or any other electronic medical equipment before using the device.



Ensure no water enters the charger plug socket and the cover is only removed during charging.



See also additional safety information in Section 7.1 *Battery Charging Safety Information*.

Observe the following warnings when using the device:



Any changes in the performance or function of the device e.g. restricted movement, non-smooth motion or unusual noises should be immediately reported to your practitioner or service provider.



Ensure only suitably retrofitted vehicles are used when driving. All persons are required to observe their respective driving laws when operating motor vehicles. While wearing the orthosis, the leg on which the orthosis is worn must not be used to control the vehicle or its components (e.g. clutch pedal, brake pedal, accelerator).



















You must not operate heavy machinery while wearing the device.





Always use a handrail when ascending and descending stairs and at any other time if available.



Leg-over-leg stairs descent should only be undertaken if you have received suitable training and have been approved to do so by your practitioner. Otherwise a step-to-step gait should be used descending stairs.

-  When starting to walk, you should always lead with the unaffected leg. If walking is initiated with the braced limb, the device may not recognize the movement and as a safety measure will switch to *Lock* mode.
-  Confirm that *Stairs* mode is engaged before attempting to descend stairs.
-  Confirm that *Sit* mode is engaged before attempting to sit.
-  The device must not be used for unusual activities, including, for example, extreme sports (free climbing, parachuting, paragliding, etc.), sport activities that involve jumping, sudden movements or fast sequences of steps (e.g., running, cycle racing, basketball, badminton, ice and snow sports) or extreme slopes and steps.
-  Avoid, where possible, using the device on slippery or unfirm surfaces (sand, snow, mud, etc.). If unavoidable, proceed with extreme caution.
-  If the critical service indicator is activated and cannot be reset (see Section 5.1 *Critical Service Indicator*), stop using the device as soon as is practicable and contact your practitioner to arrange a service.
-  You must not adjust or tamper with the setup of the device.
-  Do not modify or replace the KAFO straps or padding prescribed by the practitioner.
-  After continuous use the knee module may become hot to the touch.
-  To minimize the risk of slipping and tripping, appropriate footwear that fits securely around the foot components must be used at all times.
-  Carrying loads might affect your posture and ability to meet the required parameters for the knee to release from stance.
-  Keep the key fob on a lanyard separate from any other keys to prevent accidental mode switching.
-  To prevent damage to clothing take care not to trap clothing in the moving parts of the device.
-  Avoid any strangulation hazard that the key fob lanyard may present to the user when worn, such as catching the cord in rotating machinery.
-  When the key fob lanyard is not in use always store it away safely to avoid any strangulation hazard that it may present to children.
-  The device is not designed for walking backwards. Do not attempt to walk backwards as the device may not support you.

In *Walk* mode, when backwards motion is detected, the device will lock in extension to provide standing support only. See Section 10.3 *Activities and Associated User Modes* for details.
-  Use of accessories, transducers and cables other than those specified or provided by the manufacturer of this equipment could result in increased electromagnetic emissions or decreased electromagnetic immunity of this equipment and result in improper operation.
-  **WARNING:** Portable RF (radio frequency) communications equipment (including peripherals such as antenna cables and external antennas) should be used no closer than 30 cm (12 inches) to any part of the device, including cables specified by the manufacturer; this may otherwise result in the degradation of performance of the device.

3 Construction

Principal Parts

- Tectus Knee Module Titanium, stainless steel, aluminum, elastomer, thermoplastic, electronic components, hydraulic fluid
- Battery Module NiMH battery, thermoplastic
- Follower Joint Stainless steel, aluminum, elastomer, thermoplastic
- Knee Side-bars Titanium
- Battery Charger Thermoplastic, electronic components
- Key Fobs Thermoplastic, electronic components, Lithium battery
- Thigh, Lower Leg Shell, Straps, Ankle Module and Foot Components Refer to manufacturer's documentation

Component Identification

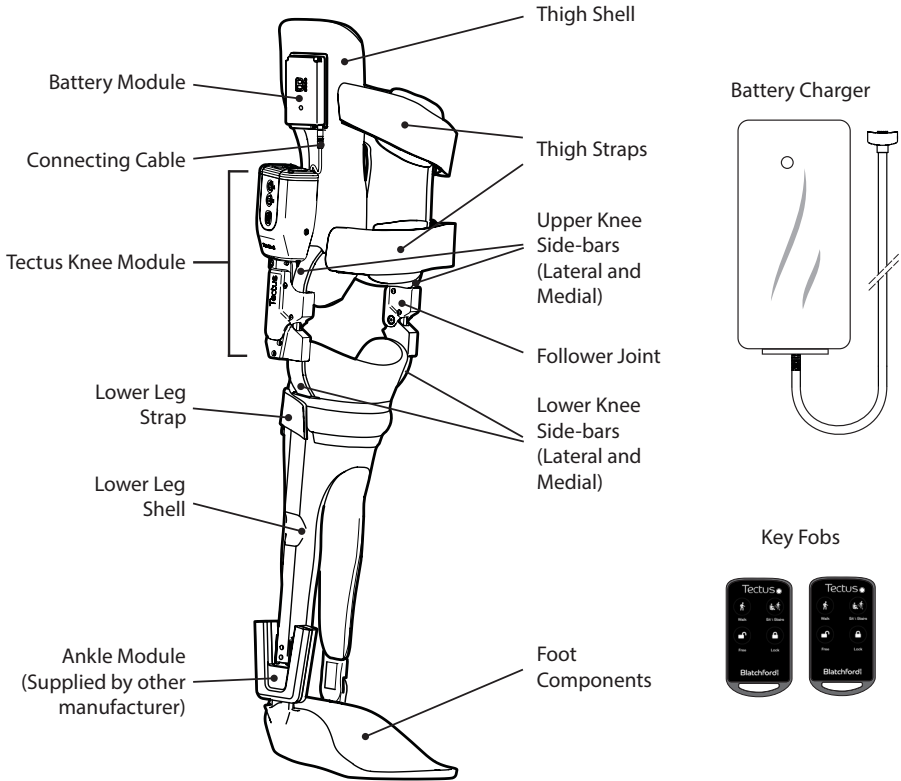

Note... For illustrative purposes, only the right leg Tectus KAFO is shown.

**Tectus Knee Module
(Right leg shown)**

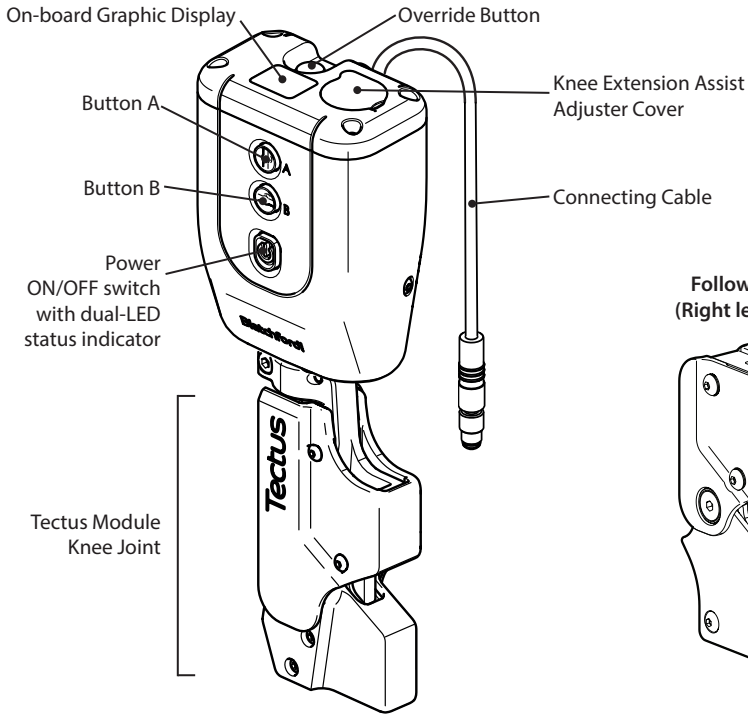

Battery Module

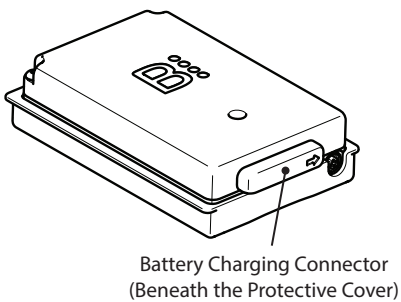

Knee Side-bars

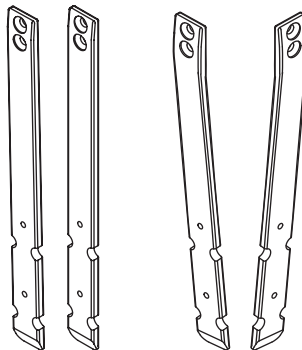

938467

4 Key Points

The microprocessor-controlled device is configured by your practitioner for your individual gait needs, and adapts in real time to your current motion situation.

A power ON/OFF button and two push buttons (A and B) on the device provide the local control through various switch pressing combinations. See Section 10.8 *Mode Switching on the Device Using Tectus Module Buttons A and/or B*.

You cannot make any adjustments to the programmed performance of the device, these must be carried out by your practitioner. However, the device allows you to switch operating modes manually using the 4-button key fob and/or A and B buttons so you can adapt device operation for specific circumstances. For example, to walk down stairs you would select **Stairs** mode just prior to starting to walk down the stairs. In **Stairs** mode the device will provide necessary additional support by increasing flexion resistance. Operation of the device and the operating modes available to the user are described in Section 10 *Tectus Knee Module Operation*.

A four-button key fob on a lanyard provides you with a remote control capability to switch the device between operating modes. See Section 10.6 *Mode Switching on the Device Using The Key Fob*.

In the event of any malfunction of the electronic or the hydraulic control system, or when the battery is fully discharged, the device automatically switches to a **Safety** mode. In this **Safety** mode the device reverts to pre-programmed resistance parameters and allows only limited functionality. Normal operation resumes when the device is first time powered on after the malfunction has been resolved, or the battery has been recharged. See Section 5.1 *Critical Service Indicator* and Section 7.3.2 *Low Battery Behavior*.

The device has a mechanical override button which allows knee flexion while pressed. See Section 10.8 *Mechanical Override Operation*.

5 Maintenance

The Tectus KAFO requires a routine inspection at the following times after fitting:

2 weeks	3 months	6 months	12 months	24 months
---------	----------	----------	-----------	-----------

These inspections must be carried out by competent personnel according to the routine inspections schedule available from Blatchford ACS.



Completion of routine inspections according to the prescribed maintenance schedule and notification of Blatchford of the results is necessary to maintain the validity of the warranty.

Do not carry out maintenance on this device yourself. Instead, return it to your practitioner/ service provider for maintenance. If the device is still under warranty, we will loan you another knee unit while we carry out maintenance. The loan device and the device returned after maintenance must be set up by the practitioner before use.

Any changes in performance of this device must be reported to the practitioner.

Changes in performance may include:

- Increase or decrease in knee stiffness
- Instability

- Reduced knee support (free movement)
- Any unrecognized beeps, warning lights, on-screen indications or device vibrations*
- Any unusual noise

*The device emits vibrations when operating modes change. This is normal behavior.



Do not lubricate the device yourself, this will be carried out during servicing with the appropriate lubricants.



Never use WD40 or any other water dispersant on any of the device moving parts in an attempt to fix unusual noises, squeaking or stiff joints.

Check the device every time before use for physical damage to the KAFO and:

- Signs of wear or tear
- Hydraulic leakage
- Security of the joint covers
- Security and condition of the straps

Replace the key fob battery either every six months or:

- when switching between knee modes becomes inconsistent or
- if the key fob LED does not illuminate every time a button is pressed

See Section 5.4 **Replacing the Key Fob Battery**. If for any reason you are unable to carry out this procedure contact your practitioner or service provider to arrange replacing your battery for you.

5.1 Critical Service Indicator

In the event of the device detecting a malfunction, the critical service indicator graphic will be activated and flash on the device screen (see image) and the device will attempt go into **Safety** mode with higher than normal knee flexion and extension resistance. Simultaneously button B will start and continue flashing Red until the malfunction is resolved.

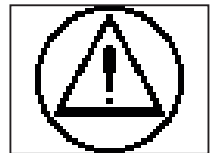

In this **Safety** mode you can slowly extend or flex the knee to allow you to move to a safe position to remove the device.



If for any reason Safety mode does not engage, stop using the device immediately.

If adjustment of the knee angle is required, the device can be allowed to flex or extend freely by operating the override button, please refer to Section 10.8.



WARNING! Only use the override button if it is safe to do so.



If the device malfunctions, and performing a hard reset (see Section 5.2) does not fix the fault, or if the Critical Service Indicator is displayed, contact your practitioner as soon as is possible, and you must not use the device until the malfunction has been fixed and/or service has been carried out as necessary.

The critical service indicator will continuously flash and the knee will remain in this mode until the malfunction is resolved. If you power down with the critical service indicator on, it will extinguish however when you next power on the device the critical service indicator will begin to flash again and continue until the malfunction is resolved.

5.2 Hard Reset

In the case of a minor and non-recurring malfunction a hard reset may be attempted to allow device self-recovery. To conduct a hard reset, power the device OFF and ON via the power ON/OFF button located on the knee module.

 **If the malfunction is persistent contact your practitioner.**

5.3 Cleaning

Blatchford recommends cleaning the device daily. Use a damp cloth and mild soap to clean outside surfaces, DO NOT use aggressive cleansers or bleach. Do not machine wash/tumble dry or use any hose, pressure washer/drier system.

Ensure water/liquids do not enter the charging socket. Thoroughly dry before use.

5.4 Replacing the Key Fob Battery

The key fob operates using a CR2032 button battery. Replacement is necessary every six months or when switching between knee modes becomes inconsistent or if the key fob LED does not illuminate every time a button is pressed.

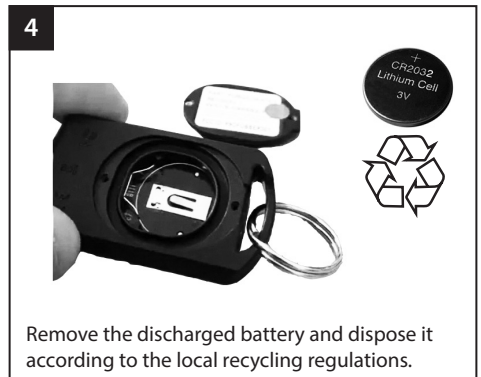
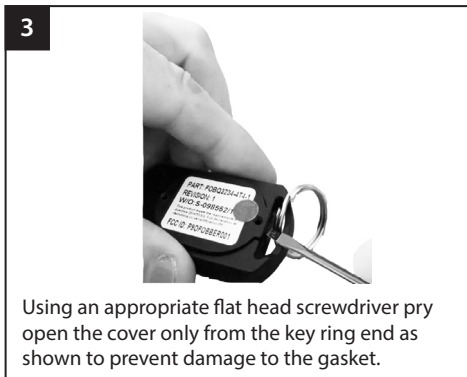
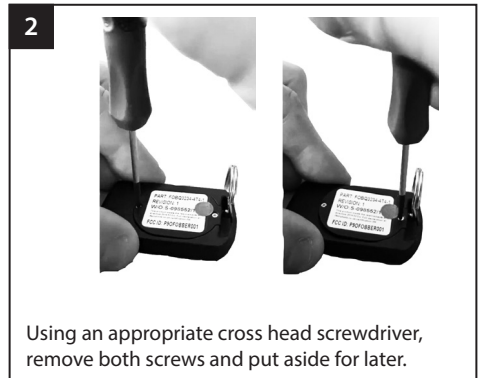

 **Batteries should be kept out of reach of children and pets. In case of ingestion, seek medical attention.**

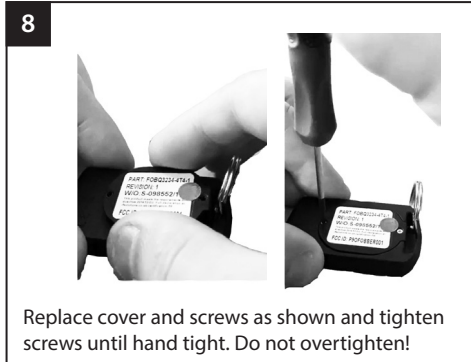
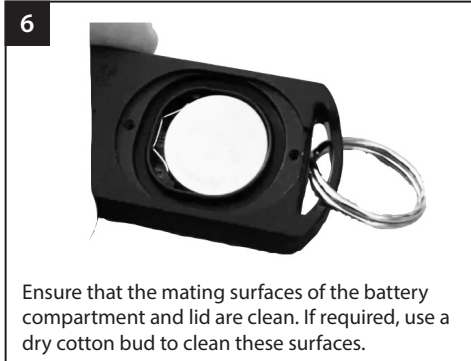

After battery replacement, confirm all key fob functionality by testing that all buttons achieve the required knee mode change when pressed and that the LED on the fob illuminates once after each time a button has been pressed.

6 Limitations on Use

Lifting Loads

User weight and activity is governed by the stated limits. Load carrying by the user should be based on a local risk assessment. The assessment should take into account that carrying loads might affect posture and ability to meet the required parameters for the knee to release from stance. The combined user weight and lifting load must not exceed 100 kg in all cases.

Environment

Avoid exposing the Tectus KAFO to corrosive elements such as water, acids and other liquids. Also avoid abrasive environments such as those containing sand for example as these may promote premature wear.

Note... Only the knee module and battery pack are waterproof to IP54 standard.















Exclusively for use between -10 °C and 50 °C (14 °F to 122 °F).



Suitable for outdoor use

7 Battery Charging

7.1 Battery Charging Safety Information

-  Never connect the charger to the device whilst still wearing it.
-  The battery should only be charged in temperatures between 0 °C to 35 °C (32 °F to 95 °F).
-  The battery charger can be used with electrical outlets rated between 100V and 240V AC, 50/60 Hz.
-  Only charge the battery of the device using the charger and charging cable supplied with the product. Do not use this charger to charge any other device.
-  Ensure the appropriate, country-specific mains adapter plug is fitted to the charger. Never force the plug into an incompatible mains socket.
-  Before charging ensure charging surfaces are dry, free from contamination and debris build-up, because this can prevent charging.
-  If any unusual noise or smell is noticed whilst charging, disconnect the charger and power off both charger and knee module. Report the problem to your practitioner.
-  The battery module and battery charger connectors contain strong magnets. Always keep a safe distance (at least 10 cm) between these magnets and all objects that can be affected by magnetism, such as watches, pacemakers, bank cards or any magnetically stored media.
-  Do not allow any ferrous material to attach itself to the charging surfaces.
-  Do not dismantle the adapter plug or battery charger.
-  Immediately replace damaged adapter plugs or battery chargers with parts supplied by Blatchford.
-  During a charging the device will power down. Once charged, the device will require powering on via the ON/OFF button located on the outer surface of the Tectus knee module.
-  Do not remove the batteries, they are not field replaceable and will be replaced as necessary, during routine inspection.
-  If the device has been subjected to temperatures lower than -10 °C (14 °F) it must be returned to Blatchford for inspection for possible damage to the battery pack.

7.2 Before Charging



The device should not be charged while being worn; remove the Tectus KAFO before charging. Do not don the device while it is connected to the charger.

Always check the battery charge level before use, ensuring a sufficient amount of charge for daily activities. It is recommended to charge the device every day when using it on a daily basis.

It is recommended that you switch the device to **Lock** mode and, before charging, lay the Tectus KAFO down in a horizontal position (on a flat surface or floor), with the knee module facing upwards and with 5 degrees of knee flexion so that it is secure and does not roll over.

Note... As soon as the charger is connected, the knee module automatically switches off.

7.3 On-Screen Battery Level Indicator

7.3.1 Normal Indications

The battery level indicator will appear for 5 seconds on the side of the on-board graphic display:

- During mode switching.
- Long pressing button A and B together.

The following battery level indications are available:

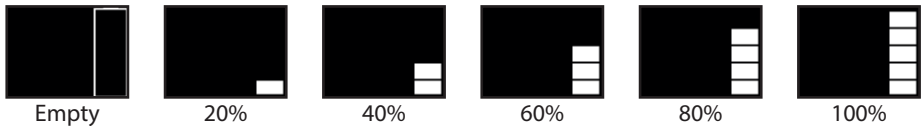

7.3.2 Low Battery Behavior

Low Battery Warning

The device will warn you when the battery charge level shown drops to 20% by emitting two short high-tone beeps and also displaying the warning symbol followed by one bar on the graphic display. This warning will be repeated every 10 minutes and/or when any button is pressed on the device until the charge in the battery reaches the critically low level.



Critically Low Battery Warning

A critically low battery level will be indicated by the warning symbol flashing and one long high-tone beep. The device will revert to a **Safe** mode identical to the one described in Section 5.1 *Critical Service Indicator*.



When the Critically Low Battery warning is indicated, you must stop using the device and not to reuse until the device has been recharged.

7.3.3 No Display after Connecting the Battery Charger

If after connecting and switching on the battery charger the device graphic display remains blank, the battery may be completely discharged. Leave the battery charger connected for at least 15 minutes and check the charge level by disconnecting and re-connecting the battery charger.

7.4 Connecting and Disconnecting the Charger

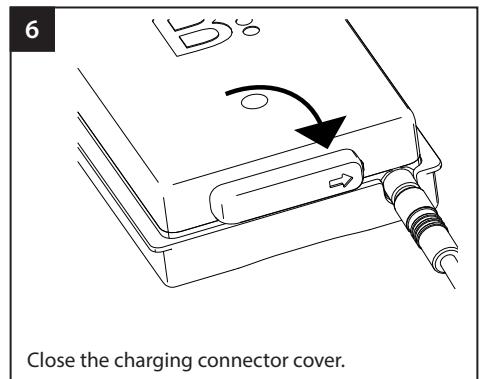
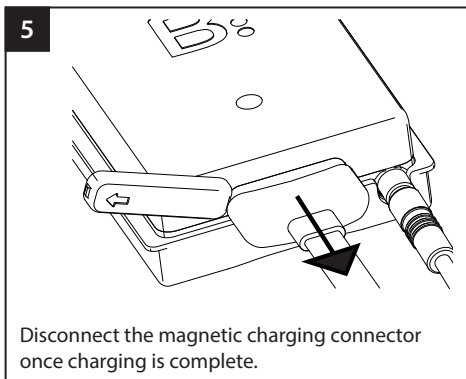
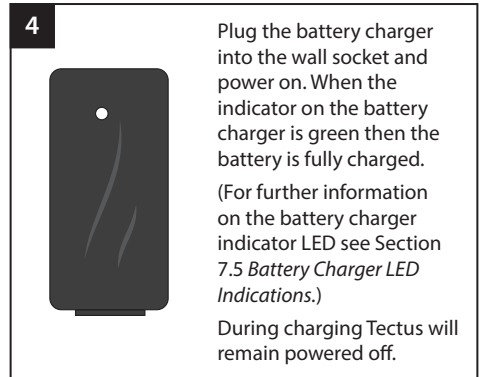
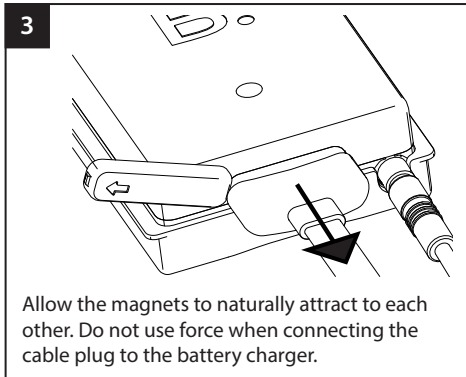
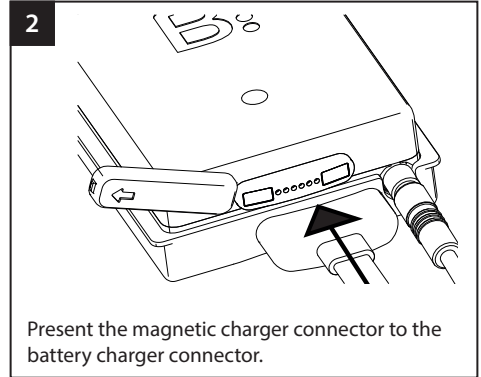
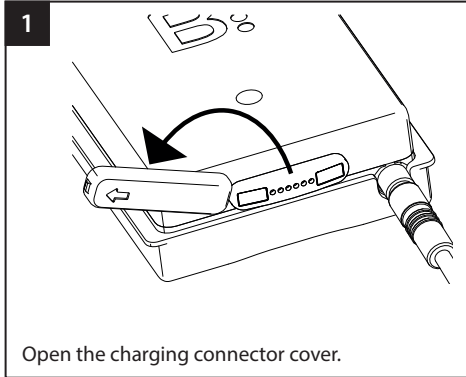

7.5 Battery Charger LED Indications

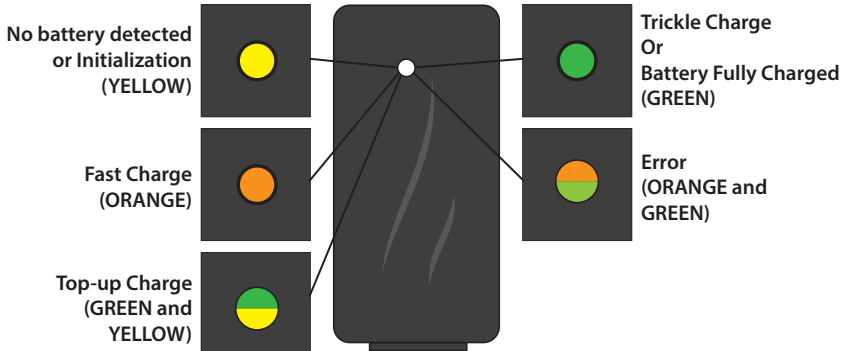

Note... Refer to the reverse side of the battery charger module and the instructions supplied with the charger for further information.



Start-Up Sequence

With the charger plugged into the mains socket, and connected to the device, switch on at the socket. The charger LED will illuminate in the following color sequence in approximately 10 seconds to indicate the device is charging.

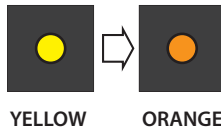

7.6 Charging and Operating Reference Times

Process	Time
Time to fully charge battery. (From fully discharged state.)	Approximately 2 hours
Minimum charging time before use. (From fully discharged state.)	At least 1 hour
Maximum battery duration, from fully charged, under continuous device operation i.e. uninterrupted walking. (Subject to operating temperatures)	18 hours (see notes i and ii)

- Notes:
- i) For the maximum operating time with one battery charge, turning the device off when it is not being used is recommended.
 - ii) The operating time of the device may be reduced at low ambient temperatures or due to aging of the battery.

8 How to Don and Doff the Tectus KAFO

8.1 Donning the Tectus KAFO

Notes: i) Charge the device before donning. (See Section 7 *Battery Charging*.)
ii) Inspect daily for signs of deterioration or damage that might affect the safety or function of the device. If anything unusual is noticed, contact your practitioner for advice.

1. Completely undo and fully open all closure straps so they are clear of the shell openings.
2. Remove the shoe.
3. Sit on the front edge of a chair.
4. Power ON the device. (See Section 9.)
5. If powered ON with the device lying horizontal, the device should be in **Free** mode after power ON; if not, then set the device to **Free** mode via key fob or module buttons.
6. Flex the Tectus KAFO at the knee.
7. Slightly extend the leg and insert the thigh into the thigh shell.
8. Insert the foot into the foot component, positioning the heel first and insert the lower leg into the lower leg shell.
9. Fasten all straps. Do not overtighten.
10. Check the fit of the orthosis for comfort. (Alter as required e.g. appropriate trim lines.)
11. Put the shoe on over the foot component. (Some users may prefer donning the Tectus KAFO with the shoe already in place.)
12. Set the device to **Walk** mode and stand up (holding on to chair for support as necessary) and adjust all closures/securing straps as required.
13. If worn over clothing, ensure clothing is folded neatly to avoid discomfort. If worn under clothing (i.e. dress, skirt, loosely fitting trousers), a sock or a thin under garment covering the full length of the leg should be worn.



To prevent damage to clothing take care not to trap clothing between the moving parts of the device.

14. Set the device to **Sit** mode and sit down again carefully.
15. Set the device to **Free** mode and gently flex and extend the knee to confirm that Tectus KAFO fits comfortably throughout the range of movement.
16. Set the device back to **Walk** mode before standing up.

8.2 Doffing the Tectus KAFO

1. Set the device to **Sit** mode.
2. Sit down on the front half of a chair (holding on to chair for support as necessary).
3. Set the device to **Free** mode.
4. Remove the shoe.
5. Open all fastening straps.
6. Remove Tectus KAFO.
7. Extend the Tectus KAFO to 5 degrees knee flexion and activate **Lock** mode on the device.
8. Power OFF the device.
9. Lay the Tectus KAFO down in a horizontal position (on a flat surface or floor), with the knee module facing upwards and with 5 degrees of knee flexion so that it is secure and does not roll over.

Note... It is recommended to put the device on charge every time after use.



Regularly check the limb on which the Tectus KAFO is worn for signs of skin irritation, tissue damage, pressure sores or discomfort and report any such signs to your practitioner.

9 Turning the Device ON/OFF

The device is powered on or off via the Power ON/OFF switch on the device, there is no Power ON/OFF switch on the key fob.

Powering ON

To power on the device, press and hold the ON/OFF switch until LED illuminates green. Short beeps and vibrations will then occur during the start-up sequence; when they finish, then release.

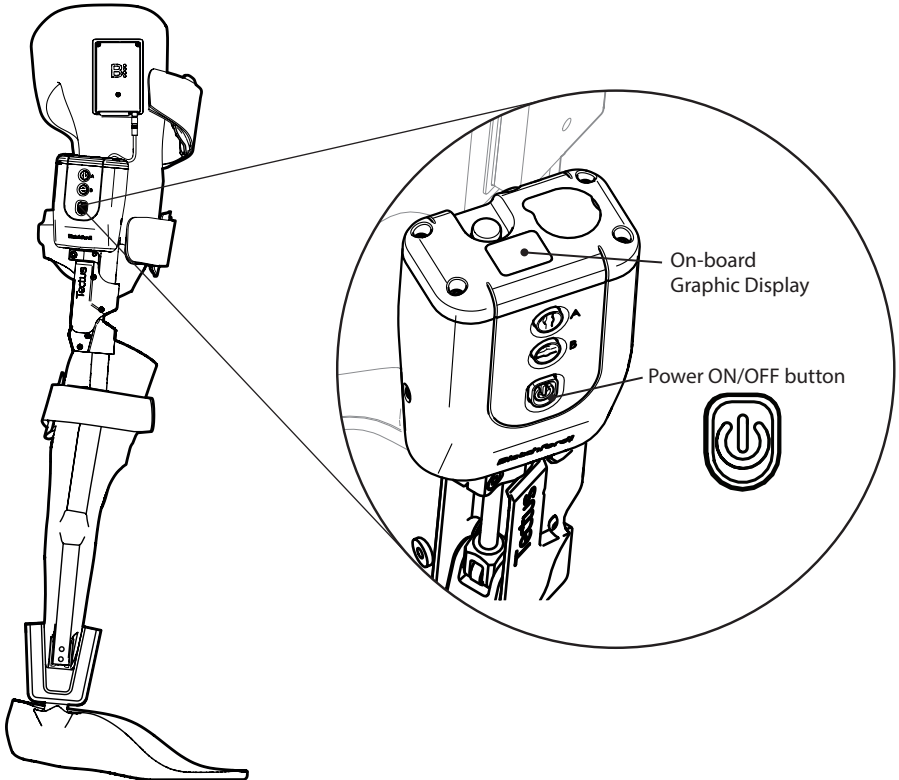

Powering OFF

To initiate the shut-down sequence, press and hold the ON/OFF switch until two short beeps with two short vibrations are emitted, then release.



Start-up Sequence

Powering ON initiates the automatic start-up sequence during which the LED and graphic display indications change, audible beeps sound and the device vibrates as shown. The sequence lasts for approximately 4 seconds.

⚠ Do not use the device if the BLUE LED continues flashing during, and on completion of, the start-up sequence. This indicates the programming of the device has not been previously completed. Contact your practitioner before using the device.

The device is powered ON and ready for use when the default **Free/Walk** mode (depending on device orientation during start-up) is displayed on the on-board graphic display, (see sequence shown on right).

Note... The display goes into sleep mode (display goes blank) after 5 seconds of inactivity but is reactivated after every user mode change initiated by either buttons A/B on the device, or buttons on the key fob.

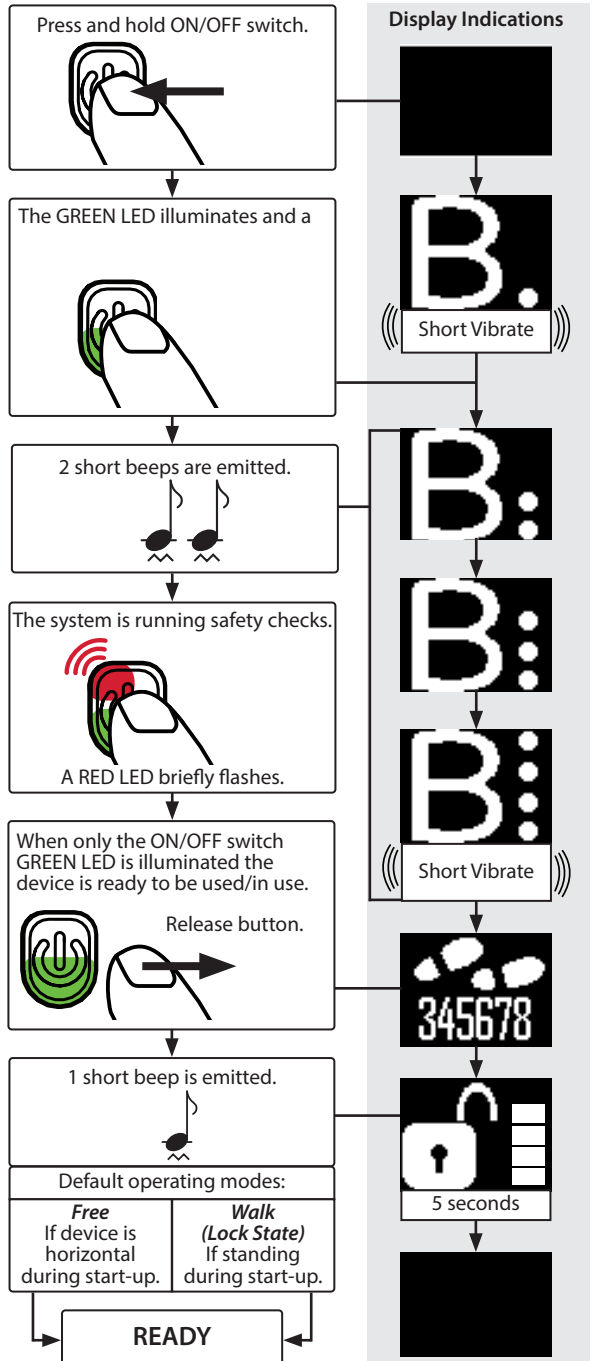

10 Tectus Knee Module Operation

10.1 User Modes

The device has the following user-selectable operating modes:

- *Walk*
- *Sit*
- *Stairs*
- *Lock*
- *Free*
- *Silent*

The device may enter automatically the following modes:

- *Critical Service*
- *Safe*

The device has the following practitioner-only selectable operating mode:

- *Training*

10.2 Safety While Switching Between User Modes

10.2.1 Default User Mode

The device after start-up, by default, switches to *Free* mode if the user is seated or *Lock* state of *Walk* mode if the user is standing. During start-up *Free* mode is only intended to be used for donning the device. Another mode (typically *Walk* mode) should be selected before standing after donning the device.

10.2.2 Safety Restrictions to User Mode Switching

The device will not allow switching to *Free* mode when the user is walking, descending stairs or standing with the knee locked. This is for safety reasons as the consequent sudden loss of support poses a considerable risk of falling. Therefore the following mode switching combinations will not be executed by the device:

Walk mode to *Free* mode



Stairs mode to *Sit* mode

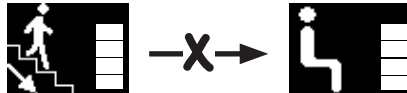

Stairs mode to *Free* mode

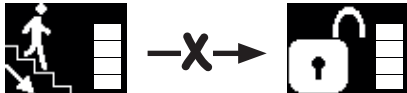

Sit mode to *Stairs* mode

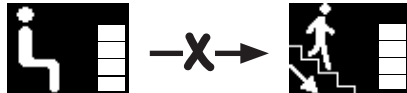

Lock mode to *Free* mode

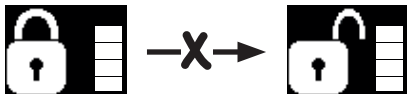

Free mode to *Stairs* mode



10.2.3 Device Over-Stress Warning

Very rarely, and under special circumstances, the device may emit a rapid beeping audio and vibration alarm, for up to 15 seconds. This indicates the device is over-stressed, through not being used as intended, or due to an internal fault.

When Stress Warning Occurs

If you take (or the device itself takes) successful remedial action to remove the over-stress condition before the end of the 15 seconds alarm period, then the alarms stop and the device resumes normal operation.

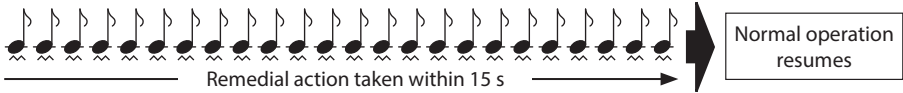

If you do not (or the device itself does not) take successful remedial action to remove the over-stress condition before the end of the 15 seconds alarm period, then the device interprets this as a fault situation and switches automatically to **Safety** mode.





















Occurrence and Avoidance of Over-stressing the Device



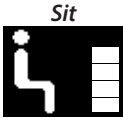

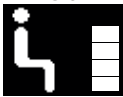

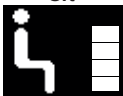
The following table summarizes the scenarios in which the device might be over-stressed and the possible remedial actions.





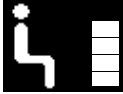

Alarm Occurrence	Reason	Remedial Action
During Mode Switching	You may have attempted to change between user modes when the previous activity had not been fully completed and the hydraulic system was not ready to adjust to the new settings.	Try to reduce the load on the device until it can execute the mode switching command. The rapid beeping should stop immediately to indicate that normal operation has been resumed. Always allow sufficient time for the device to respond to mode switching commands.
During Sitting Down	During the process of sitting down the device automatically switches to a lower resistance after about a 45° of movement. If you attempt to sit down too quickly and forcefully, it over-stresses the hydraulic system during mode switching.	Try to reduce the load on the device until it is able to switch to Free mode. Follow your practitioner's advice on the correct way and speed of sitting down while wearing the device.
In Case of a Malfunction	If the remedial action does not fix the problem within the 15 seconds alarm period at the end of this period, the device will assume there is a malfunction and revert to Safety mode and the critical service indicator will appear on the device screen.	Please refer to Section 5.1 Critical Service Indicator on how to deal with a malfunction and for the description of Safety mode

10.3 Activities and Associated User Modes

Activity	Mode Activated and Displayed	Function and Procedure Guidance
Walking 	<p style="text-align: center;"><i>Walk</i></p> 	<p>Automatically provides support during stance and release during swing. Although not microprocessor controlled, knee extension assist is always active.</p>
Standing 	<p style="text-align: center;"><i>Walk</i></p>  <p style="text-align: center;"><i>Lock</i></p> 	<p>If you stand still while in <i>Walk</i> mode, you will be supported. From standing, the device will be alert to any movement, such as a forward or backward step and provide support accordingly.</p> <p>To provide appropriate support, using <i>Lock</i> mode is recommended when standing for an extended period of time (e.g., queuing) or in an environment where your balance can be compromised (e.g., standing in a crowd).</p> <p>Note... <i>Lock</i> mode is a fixed mode, and the device does not monitor for movement. <i>Lock</i> mode needs to be set and released manually.</p>
Backstep 	<p style="text-align: center;"><i>Walk</i></p> 	<p>If you step backwards or lean backwards while in Walk mode, the device goes into a locked state called Backstep. This gives you support while you rebalance.</p> <p>Note... <i>Backstep</i> is a state within <i>Walk</i> mode and is not the same as the user-selectable Lock mode.</p> <p>If <i>Training</i> mode is enabled, the device indicates it has gone into this <i>Backstep</i> state by emitting 1 long high-tone beep and 1 vibration.</p> <p>The device reverts to standing <i>Lock</i> state only after you have returned to and remained in the standing position for at least 2 seconds. If <i>Training</i> mode is enabled, this is indicated by the device emitting two beeps and vibrations.</p>
Lock 	<p style="text-align: center;"><i>Lock</i></p> 	<p>Knee locked against flexion but free to extend until maximum extension is achieved.</p> <p><i>Lock</i> mode will remain active until another mode is selected or until the mechanical override button is pressed.</p>
Free 	<p style="text-align: center;"><i>Free</i></p> 	<p>The device provides minimal resistance in flexion and minimum amount extension assist resistance in extension.</p> <p><i>Free</i> mode will remain active until another mode is selected.</p> <p> This mode does not provide sufficient support for standing.</p>

Activity	Mode Activated and Displayed	Function and Procedure Guidance
Stand-to-Sit 		<p>Fixed resistance at knee to provide support while moving to seated position, the geometry of the module provides deep yield functionality.</p> <p>To sit, you must manually activate Sit mode via mode switching buttons on the device or on the key fob.</p> <p>Be aware of the surroundings before sitting down. Load both legs equally when sitting down. Bend forward at the waist, push buttocks rearward, place hands on armrests (if available) and bend the legs, sitting down in a smooth motion.</p>
Sitting 	 	<p>In Sit mode after 2 seconds of achieving a resting position the device automatically switches to Free mode to allow, if necessary, adjustment of limb position while sitting.</p> <p>Note... The device will start up in this Free mode when start-up is initiated while you are in a seated position.</p> <p>While in Sit mode the device will detect when you attempt to stand and locks against flexion as you rise, so you cannot sit back down again until either the leg is fully extended or the override button is pressed.</p>
Sit-to-Walk 		<p>When in Sit mode the device detects when you attempt to stand up and start walking and enters into Walk mode automatically.</p> <p>To stand up, the feet should be placed evenly, move the trunk forward and stand up with the support of your arms. Try to load weight through the orthosis and begin walking.</p> <p>⚠ If you do not complete the motion and attempt to sit back down again the device will lock against flexion.</p>
Stairs Ascent 		<p>⚠ For safety, switch manually to Lock mode before starting to ascend stairs.</p> <p>⚠ Where possible, handrails must always be used.</p> <p>When Lock mode is used the knee will not yield (although it can extend), so a “step-to” gait should be used leading with the sound limb going up stairs.</p>

Activity	Mode Activated and Displayed	Function and Procedure Guidance
<p>Stairs Descent</p> 	<p><i>Stairs</i></p>  <p><i>Lock</i></p> 	<p>⚠ In <i>Stairs</i> mode, do not attempt to descend stairs using leg-over-leg gait until you have had adequate physiotherapy and completed supervised training signed off by your practitioner!</p> <p>⚠ Always approach stairs with caution and be aware of your surroundings.</p> <p>⚠ Where possible, handrails must always be used.</p> <p>⚠ For stairs decent, either <i>Stairs</i> mode or <i>Lock</i> mode must be enabled before starting descent and once selected, you must not change it to another mode until the stairs decent is complete.</p> <p><i>Stairs</i> mode provides appropriate support for leg-over-leg descent with programmed flexion resistance combined with appropriate extension bias.</p> <p>Note. . . Place only the posterior half of the foot on the step then load orthosis and push it in to knee flexion, step down with the sound limb and allow knee flexion on the orthotic limb.</p> <p>When <i>Lock</i> mode is used the knee will not yield, it is locked in full extension, so a “step-to” gait should be used, leading with the locked fitted limb going down the stairs.</p>
<p>Entering Vehicle</p> 	<p><i>Sit</i></p> 	<p>⚠ Always approach vehicles with caution and be aware of your surroundings.</p> <p>To sit into the vehicle, you should activate <i>Sit</i> mode.</p> <p>The device will enter <i>Free State</i> of <i>Sit</i> mode when the thigh is horizontal. (Not identical to <i>Free</i> mode.) This allows you to manoeuvre the limb into a comfortable and safe position.</p> <p>Note. . . If the thigh angle is not horizontal e.g., due to the angle of the vehicle seating surface, then the device will enter <i>Sit-to-Stand State</i> of <i>Sit</i> mode and can only be positioned by using the mechanical override button.</p>
<p>Exiting Vehicle</p> 	<p><i>Sit</i></p> 	<p>Before exiting the vehicle make sure the device is in <i>Sit</i> mode so that when you exit the vehicle you are supported as you move from sitting to standing and is ready to switch automatically to <i>Walk</i> mode.</p>

Activity	Mode Activated and Displayed	Function and Procedure Guidance
<p>Driving</p> 	<p><i>Free</i></p> 	<p> You must not operate the device controls or key fob while driving.</p> <p> Warnings in this document and any national guidance must be followed when considering driving while wearing a Tectus KAFO.</p> <p> Only the unaffected leg may be used to operate controls of a car.</p> <p>For driving, the device should be manually switched to <i>Free</i> mode via the key fob or the device buttons.</p>
<p>Safe Mode</p>		<p>The device will revert into <i>Safe</i> mode every time a malfunction or critically low battery level is detected, or when the service mode warning period has expired. In <i>Safe</i> mode the device will switch to high yielding knee flexion resistance.</p> <p>See Section 5.1 <i>Critical Service Indicator</i> and Section 7.3.2 <i>Low Battery Behavior</i> for more details.</p>
<p>Critical Service</p>		
<p>Training</p>	<p><i>Training</i></p>	<p>Note... Training mode can only be enabled through practitioner (clinician) level access to the app.</p> <p>In <i>Training</i> mode, aural and vibrational cues are provided to indicate when an operating state change within <i>Walk</i> mode has been made to help you learn how to use the device.</p> <p>For example, when you make the appropriate first step movement from stationary to activate <i>Backwards Walk</i> state, the device emits one long beep and vibrates to confirm <i>Backwards Walk</i> state has been selected. Similarly, if you stop walking to stand still, the device emits two short beeps and vibrates to confirm <i>Lock</i> state has been selected.</p>









10.4 Operating Actions and Device Indications

Device and Key Fob Button Operation

The device is manually operated by pressing either buttons A and/or B on the device, or by pressing buttons on one of the key fobs. The button or button combination pressed, together with the hold duration (Short, Long or Very Long) of the press determines which operation is selected.









Note... Key fob buttons have only two options; Short or Long press.

To help the user distinguish between the three different press durations, for each press duration the device emits a corresponding unique pattern of beeps and vibrations, and displays a corresponding icon on the screen, as shown in the following table:

Name	Duration	Timing Beeps with Vibrations	On-screen Icon	Symbol Used in Document
Short Press	Max. 2 seconds			
Long Press	2-4 seconds			
Very Long Press	Longer than 4 seconds			





















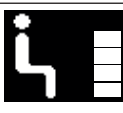











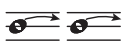

Device Indications

The device will acknowledge that the requested operation, e.g. change of mode, has been registered by the device by emitting audible and/or vibrational cues as shown in the following table:

Type of Indication	Symbol Used in Document	
	Short	Long
Audible (Beep)	High Tone 	
	Medium Tone 	
	Low Tone 	
Vibration		
On Screen	See detailed description in Section 10.3, 10.5 and 10.6.	
ON/OFF Switch LED Light	See detailed description in Section 9.	

10.5 Mode Switching on the Device Using Tectus Module Buttons A and/or B

Once start-up routine has successfully completed, the device can be controlled with button combinations on the Tectus Knee Module or Key Fob.

Modes	Initiation (On Device)	Timing Aid		Device Response		
		On Screen	Beep & Vibrate	Beep Signal	Vibrate Signal	Displayed Symbol
<i>Walk</i>	Short Press button A 		1 	2xLow tone short 	2xShort 	
<i>Sit</i>	Long Press button B 		1+2 	1xMedium tone short 	1xShort 	
<i>Stairs</i>	Short Press button B 		1 	2xMedium tone short 	2xShort 	
<i>Free</i>	Short Press button A&B 		1 	1xMedium tone long 	1xLong 	
<i>Lock</i>	Long Press button A 		1+2 	2xMedium tone long 	2xLong 	
<i>Silent</i>	Very Long Press button A 		1+2+3 	2xMedium tone short 	2xShort 	

Note... Do not press button B for more than 4 seconds or you may accidentally switch on **Bluetooth®** as indicated by the power button illuminating flashing blue and steady green and emitting three low tones and vibrations. This is not a user function and must be switched off. To do this, power off the device and power on again using the ON/OFF switch (see Section 9), or press button B for longer than 4 seconds.



10.6 Mode Switching on the Device Using The Key Fob

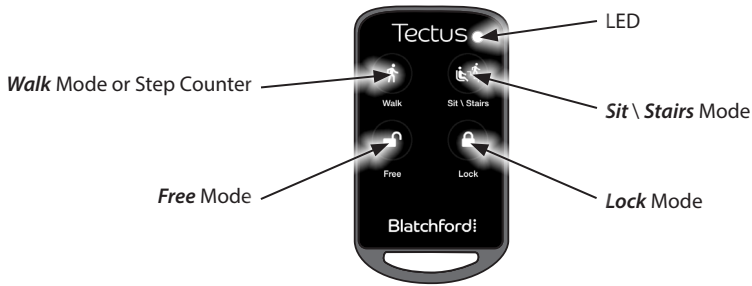

Modes	Initiation (On Fob)	Timing Aid		Device Response		
		On Screen	Beep & Vibrate	Beep Signal	Vibrate Signal	Displayed Symbol
<i>Walk</i>	Short Press Walk button			2xLow tone short 	2xShort 	
<i>Sit</i>	Short Press Sit \ Stairs Button 			1xMed. tone short 	1xShort 	
<i>Stairs</i>	Long Press Sit \ Stairs Button 		1+2 	2xMed. tone short 	2xShort 	
<i>Free</i>	Short Press Free button			1xMed. tone long 	1xLong 	
<i>Lock</i>	Short Press Lock button			2xMed. tone short 	2xShort 	

10.7 Additional Key Fob Functions

Modes	Initiation (On Fob)	Timing Aid		Device Response		
		On Screen	Beep & Vibrate	Beep Signal	Vibrate Signal	Displayed Symbol
Step Counter	Long Press Walk button		1+2 	-	-	
Connection Code	Long Press Lock Button		1+2 	-	-	

10.8 Mechanical Override Operation

The knee can be flexed in any mode by pressing the manual override button located on the top surface of the control module. The button must be pressed and held down fully until the desired knee flexion angle has been achieved.



Do not use any object (e.g. screwdriver, pen) to press the override button.



This operation should only be used in exceptional circumstances (e.g. device malfunction, battery depletion).

Once the manual override button is released the knee flexion reverts to the same resistance it had before the manual override button was pressed.

Note... The hydraulic module has been designed to always permit free leg extension.



Be aware of finger trap hazard at all times when flexing the device.

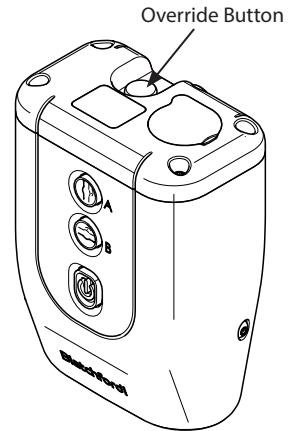

11 Transport and Storage

1. It is recommended to store the device upright with the device put into **Lock** mode before switching off.
2. If the Tectus KAFO is to be stored upright then secure the device to prevent it falling over.
3. If the device is shipped either on its own or built into a Tectus KAFO it should be put into **Lock** mode in an extended position and packaged in a suitable box to allow this.
4. If a device is to be returned, contact Blatchford prior to sending if any obvious physical damage has occurred to the battery pack.
5. For transport purposes the unit must be switched off, and packed securely so that
 - a) it cannot be inadvertently switched on and become operative while in transit,
 - b) the Tectus KAFO/device is thoroughly protected from damage in transit.

FCC Compliance Statement



This device complies with part 15 of the FCC Rules.

Operation is subject to the following two conditions:

1. This device may not cause harmful interference.
2. This device must accept any interference received, including interference that may cause undesired operation.

Note... Contains pre-approved **Bluetooth**® module: FCC ID: QOO-GM220P IC: BGM220PC22HNA2.

This equipment has been tested and found to comply with the limits for a Class B digital device, pursuant to part 15 of the FCC Rules. These limits are designed to provide reasonable protection against harmful interference in a residential installation. This equipment generates uses and can radiate radio frequency energy and, if not installed and used in accordance with the instructions, may cause harmful interference to radio communications. However, there is no guarantee that interference will not occur in a particular installation. If this equipment does cause harmful interference to radio or television reception, which can be determined by turning the equipment off and on, the user is encouraged to try to correct the interference by one or more of the following measures:

- Reorient or relocate the receiving antenna.
- Increase the separation between the equipment and receiver.
- Connect the equipment into an outlet on a circuit different from that to which the receiver is connected.
- Consult the dealer or an experienced radio/ TV technician for help.

Any changes or modifications not expressly approved by the party responsible for compliance could void the user's authority to operate the equipment.

Caution: Exposure to Radio Frequency Radiation. This device must not be co-located or operating in conjunction with any other antenna or transmitter.

Responsible party: Blatchford Inc.

1031 Byers Road, Miamisburg, OH 45342
800-548-3534 (toll free) | 937-291-3636
customerservice@blatchfordus.com

RSS Compliance Statement

This device complies with RSS 210 of Industry Canada.

Operation is subject to the following two conditions:

1. this device may not cause interference, and
2. this device must accept any interference, including interference that may cause undesired operation of this device.

L' utilisation de ce dispositif est autorisée seulement aux conditions suivantes:

1. il ne doit pas produire d'interférence et
2. l' utilisateur du dispositif doit être prêt à accepter toute interférence radioélectrique reçue, même si celle-ci est susceptible de compromettre le fonctionnement du dispositif.

Caution: Exposure to Radio Frequency Radiation.

The installer of this radio equipment must ensure that the antenna is located or pointed such that it does not emit RF field in excess of Health Canada limits for the general population; consult Safety Code 6, obtainable from Health Canada's website Blatchford Inc. 1031 Byers Road, Miamisburg, OH 45342.

800-548-3534 (toll free) | 937-291-3636 customerservice@blatchfordus.com

Liability

The manufacturer recommends using the device only under the specified conditions and for the intended purposes. The device must be maintained according to the instructions for use supplied with the device. The manufacturer is not liable for any adverse outcome caused by any component combinations that were not authorized by them.

CE Conformity

This product meets the requirements of the European Regulation EU 2017/745 for medical devices. This product has been classified as a class I device according to the classification rules outlined in Annex VIII of the regulation. The EU declaration of conformity certificate is available at the following internet address: www.blatchford.co.uk



Medical Device



Single Patient – multiple use

Warranty

This device is warranted for 36 months.

A routine inspection of the device is required after 2 weeks, 3 months, 6 months, 12 months and 24 months.

The user should be aware that changes or modifications not expressly approved could void the warranty, operating licenses and exemptions.

The above may vary by market; consult your local representative for details.

See the Blatchford website for the current full warranty statement.

Reporting of Serious Incidents

In the unlikely event of a serious incident occurring in relation to this device it should be reported to the manufacturer and your national competent authority.

Environmental Aspects



This symbol indicates that the product contains electrical/electronic components and/or batteries that should not be disposed of in general waste or be incinerated at the end of the product's life.

At the end of the product's life, all electrical/electronic components and/or batteries should be recycled or disposed of in accordance with the current regulations for the handling of WEEE (Waste Electrical and Electronic Equipment), or equivalent local regulations. The remainder of the product should also be recycled where possible in accordance with local waste recycling regulations.

To help prevent potential harm to the environment or to human health from uncontrolled waste disposal, Blatchford offers a take-back service. Please contact Customer Services for details.

Trademark Acknowledgements

Tectus and Blatchford are registered trademarks of Blatchford Products Limited.

The Bluetooth® word mark and logos are registered trademarks owned by Bluetooth SIG Inc., and any use of such marks by Blatchford is under License. Other trademarks and trade names are those of their respective owners.

Manufacturer's Registered Address

 Blatchford Products Limited, Lister Road, Basingstoke RG22 4AH, UK.

Inhalt.....	32
1 Beschreibung und Verwendungszweck	33
2 Sicherheitsinformationen	34
3 Aufbau.....	36
4 Wichtige Punkte.....	38
5 Wartung.....	38
5.1 Anzeige für kritischen Service	39
5.2 Hard-Reset	40
5.3 Reinigung.....	40
5.4 Austausch der Batterie in der Fernbedienung	40
6 Verwendungseinschränkungen.....	41
7 Laden des Akkus.....	42
7.1 Sicherheitshinweise zum Aufladen des Akkus.....	42
7.2 Vor dem Aufladen	43
7.3 Anzeige des Akkustands auf dem Bildschirm.....	43
7.4 Anschließen und Trennen des Ladegeräts.....	44
7.5 LED-Anzeigen des Akkuladegeräts.....	45
7.6 Referenzzeiten für das Aufladen und den Betrieb	45
8 Wie Sie die Tectus-KAFO an- und ablegen	46
8.1 Anlegen der Tectus-KAFO	46
8.2 Ablegen der Tectus-KAFO	47
9 Ein- und Ausschalten des Produkts	48
10 Bedienung des Tectus Kniemoduls.....	50
10.1 Anwendermodi.....	50
10.2 Sicherheit beim Umschalten zwischen den Anwender-Modi	50
10.3 Aktivitäten und zugehörige Benutzermodi.....	52
10.4 Bedienvorgänge und Anzeigen des Produkts	56
10.5 Moduswechsel am Produkt mit den Tectus-Modul-Tasten A und/oder B.....	57
10.6 Einschalten des Produkts mit Hilfe der Fernbedienung	58
10.7 Zusätzliche Funktionen der Fernbedienung.....	58
10.8 Mechanischer Override-Betrieb.....	59
11 Transportieren und Lagern.....	59



Bitte lesen Sie alle Sicherheitswarnungen in Abschnitt 2 und 7, bevor Sie das Produkt konfigurieren oder verwenden.

1 Beschreibung und Verwendungszweck

Diese Anweisungen richten sich nur an den Anwender (Träger).

Der Begriff „Produkt“ bezieht sich in dieser Bedienungsanleitung auf Tectus, ein Kniesystem, das aus dem Tectus-Kniemodul, dem Mitläufergelenk, dem Akku, den Seitenstäben und der dazugehörigen Fernbedienung zur Steuerung besteht. Die Begriffe „Tectus-KAFO“ („Knee-Ankle-Foot Orthosis“, Knie-Knöchel-Fuß-Orthese) und „Orthese“ beziehen sich in dieser Bedienungsanleitung auf eine maßgefertigte vollständige Beinorthese, in die das Produkt integriert ist und gemäß Verordnung des Fachpersonals hergestellt wurde.

Hinweis... Das Sprunggelenk wird nicht von Blatchford hergestellt und fällt nicht unter diese Bedienungsanleitung. Siehe Herstellerunterlagen.

Der Begriff „Programmiergerät“ wird in dieser Bedienungsanleitung als Bezeichnung für ein Tablet oder Mobiltelefon mit Android- oder iOS-Betriebssystem verwendet.

Der Begriff „App“ wird in dieser Bedienungsanleitung als Bezeichnung für die Tectus-Programmieranwendung verwendet, die sich auf dem Programmiergerät befindet.

Stellen Sie sicher, dass Sie die gesamte Gebrauchsanweisung verstanden haben, und beachten Sie insbesondere die Abschnitte mit Wartungs- und Sicherheitsinformationen.

Anwendung

Dieses Produkt ist ausschließlich als Teil einer Orthese der unteren Extremität vorgesehen.

Es wurde für einen einzelnen Anwender konzipiert.

Dieses Produkt ist ein CE-gekennzeichnetes Medizinprodukt der Klasse I gemäß der Medizinprodukteverordnung 2017/745, das zur Verwendung als Bestandteil einer Orthese für die unteren Extremitäten bestimmt ist. Die Orthese ist ein maßgefertigtes Medizinprodukt. Als Teil eines KAFO ist das Produkt ein mikroprozessorgesteuertes Schwung- und Standgerät, das die automatische Einstellung des Flexionswiderstands und die manuelle Einstellung des Extensionswiderstands ermöglicht.

Das Produkt ermöglicht es Ihnen, Tätigkeiten wie Gehen, Stehen, Sitzen und Treppensteigen zu verrichten. Das Produkt kann durch Umschalten zwischen verschiedenen Betriebsmodi für unterschiedliche Aktivitäten gesteuert werden, indem die Steuertasten am Produkt und/oder an einer Fernbedienung verwendet werden. Das Fachpersonal kann diese Steuerungen auch in Verbindung mit der App verwenden, um den Betrieb des Produkts an Ihre Bedürfnisse anzupassen.

2 Sicherheitsinformationen



Das Warnsymbol hebt wichtige Sicherheitsinformationen hervor, die genau befolgt werden müssen.



Kontaktieren Sie das Fachpersonal, wenn sich Ihr Zustand ändert.



Die Gliedmaße, an der die Tectus-KAFO getragen wird, muss regelmäßig auf Hautreizungen, Gewebeschäden, Druckgeschwüre oder Unwohlsein untersucht werden. Suchen Sie bei solchen Symptomen das Fachpersonal auf.



Zusammenbau, Programmierung, Wartung und Reparatur des Produkts (einschließlich Handhabung und Austausch der Akkueinheit) dürfen nur von entsprechend qualifiziertem Fachpersonal oder Technikern durchgeführt werden, die an einer zertifizierten Schulung teilgenommen haben.



Achten Sie zu jeder Zeit darauf, dass Finger nicht eingeklemmt werden können.



Nicht in der Nähe einer Wärmequelle abstellen. Keiner direkten Sonneneinstrahlung aussetzen oder bei warmer Witterung in Fahrzeugen liegen lassen.



Starke Magnetfelder, radioaktive Umgebungen, elektrische Störquellen und Atmosphären mit Flüssigkeiten und/oder Staub vermeiden.



Das Produkt nicht während eines Scanvorgangs (z. B. Röntgen-, CT- oder MRT-Scan) tragen.



Das Produkt nicht im Wasser oder beim Duschen benutzen. Wenn die Orthese mit Wasser in Berührung kommt, muss sie umgehend abgenommen und getrocknet werden.



Jegliche übermäßige Veränderungen der Absatzhöhe nach der Anpassung können sich nachteilig auf die Funktion der Orthese auswirken. Mit der Orthese dürfen nur von dem Fachpersonal zugelassene Schuhe verwendet werden.



Informieren Sie vor Verwendung des Produkts das Fachpersonal, wenn Sie einen Schrittmacher oder andere elektronische Medizinprodukte verwenden.



Darauf achten, dass kein Wasser in die Ladebuchse gelangt und dass die Abdeckung nur während des Ladevorgangs entfernt wird.



Siehe auch zusätzliche Sicherheitsinformationen in Abschnitt 7.1 *Sicherheitshinweise zum Aufladen des Akkus.*

Bei der Verwendung des Produkts sind die folgenden Warnhinweise zu beachten:



Sämtliche Veränderungen in der Leistung oder Funktionsfähigkeit des Produkts, wie z. B. eine eingeschränkte Bewegung, ungleichmäßige Bewegung oder ungewöhnliche Geräusche, sollten sofort dem Fachpersonal oder Dienstleister mitgeteilt werden.



Beim Autofahren dürfen nur entsprechend umgebaute Fahrzeuge verwendet werden. Alle Personen müssen beim Führen von Kraftfahrzeugen die jeweils geltenden Verkehrsvorschriften befolgen. Während des Tragens der Orthese darf das Bein, an dem die Orthese getragen wird, nicht zur Steuerung eines Fahrzeugs oder seiner Komponenten (z. B. Kupplungspedal, Bremspedal, Gaspedal) verwendet werden.





















Während des Tragens des Produkts dürfen keine schweren Maschinen bedient werden.



Beim Treppauf- und abgehen oder in ähnlichen Situationen immer ein Geländer benutzen, falls vorhanden.



Das alternierende Hinabsteigen von Treppen sollte nur durchgeführt werden, wenn Sie eine geeignete Schulung erhalten haben und das Fachpersonal Sie dafür zugelassen hat. Andernfalls müssen Treppen Stufe für Stufe hinuntergegangen werden.

-  Wenn Sie zu gehen beginnen, sollten Sie immer mit dem nicht betroffenen Bein vorangehen. Wenn das Gehen mit der gestützten Gliedmaße eingeleitet wird, erkennt das Produkt die Bewegung möglicherweise nicht und schaltet als Sicherheitsmaßnahme in den *Arretierungsmodus*.
-  Vergewissern Sie sich, dass der *Treppenmodus* aktiviert ist, bevor Sie versuchen, eine Treppe hinabzusteigen.
-  Vergewissern Sie sich, dass der *Sitzmodus* aktiviert ist, bevor Sie versuchen zu sitzen.
-  Das Produkt darf nicht für ungewöhnliche Aktivitäten verwendet werden, wie z. B. Extremsportarten (Freeclimbing, Fallschirmspringen, Gleitschirmfliegen usw.), Sportaktivitäten, die mit Sprüngen, plötzlichen Bewegungen oder schnellen Schrittfolgen verbunden sind (z. B. Laufen, Radrennen, Basketball, Badminton, Eis- und Schneesport) oder für extreme Steigungen und Stufen.
-  Vermeiden Sie, wenn möglich, das Produkt auf rutschigem oder unbefestigtem Untergrund (Sand, Schnee, Schlamm usw.) zu benutzen. Wenn es unvermeidlich ist, gehen Sie mit größter Vorsicht vor.
-  Wenn die Anzeige für kritischen Service aktiviert ist und nicht zurückgesetzt werden kann (siehe Abschnitt 5.1 *Anzeige für kritischen Service*), hören Sie so bald wie möglich auf, das Produkt zu benutzen, und wenden Sie sich an das Fachpersonal, um einen Service zu vereinbaren.
-  Sie dürfen die Einstellungen des Produkts nicht verändern oder manipulieren.
-  Nicht die von dem Fachpersonal verordneten KAFO-Riemen oder Polsterungen verändern oder ersetzen.
-  Nach längerem Gebrauch kann sich das Kniemodul heiß anfühlen.
-  Um das Sturz- und Stolperrisiko zu minimieren, müssen stets geeignete Schuhe getragen werden, die sicher um die Fußkomponenten passen.
-  Das Tragen von Lasten kann sich auf Ihre Körperhaltung und Ihre Fähigkeit auswirken, die erforderlichen Parameter zu erfüllen, damit sich das Knie aus der Arretierung lösen kann.
-  Die Fernbedienung an einem Schlüsselband getrennt von allen anderen Schlüsseln aufbewahren, um ein versehentliches Umschalten des Modus zu verhindern.
-  Um Schäden an der Kleidung zu vermeiden, sicherstellen, dass keine Kleidung in den beweglichen Teilen des Produkts eingeklemmt wird.
-  Jegliche Strangulierungsgefahr vermeiden, die das Schlüsselband für den Anwender darstellen kann, wenn er es trägt, wie z. B. das Hängenbleiben des Bandes an rotierenden Maschinen.
-  Wenn Sie das Schlüsselband der Fernbedienung nicht verwenden, bewahren Sie es stets sicher auf, um jegliche Strangulierungsgefahren für Kinder zu verhindern.
-  Das Produkt ist nicht zum Rückwärtsgehen ausgelegt. Versuchen Sie nicht, rückwärtszugehen, da das Produkt unter Umständen keine Unterstützung bietet. Wenn im *Gehmodus* eine Rückwärtsbewegung erkannt wird, rastet das Produkt in der Extension ein, so dass nur noch Stehen unterstützt wird. Siehe Abschnitt 10.3 *Aktivitäten und zugehörige Benutzermodi* für weitere Einzelheiten.
-  Die Verwendung von Zubehör, Wandlern und Kabeln, die nicht vom Hersteller dieses Produkts angegeben oder bereitgestellt werden, kann zu erhöhten elektromagnetischen Emissionen oder verminderter elektromagnetischer Störfestigkeit dieses Produkts und zu fehlerhaftem Betrieb führen.
-  **ACHTUNG:** Bei tragbaren HF-Kommunikationsgeräten (Funkfrequenz) (einschließlich Peripheriegeräten wie Antennenkabeln und externen Antennen) muss ein Mindestabstand von 30 cm zu allen Teilen des Produkts eingehalten werden. Dies gilt auch für vom Hersteller angegebene Kabel, da dies sonst zu einer Leistungsver schlechterung des Produkts führen kann.

3 Aufbau

Hauptteile

- Tectus-Kniemodul Titan, Edelstahl, Aluminium, Elastomer, Thermoplast, Elektronikkomponenten, Hydraulikflüssigkeit
- Akkumodul NiMH-Akku, Thermoplast
- Mitläufergelenk Edelstahl, Aluminium, Elastomer, Thermoplast
- Knieseitenstäbe Titan
- Akkuladegerät Thermoplast, Elektronikkomponenten
- Fernbedienung Thermoplast, Elektronikkomponenten, Lithiumbatterie
- Oberschenkel, Unterschenkelschale, Riemen, Knöchelmodul und Fußkomponenten siehe Herstellerdokumentation

Komponentenidentifikation

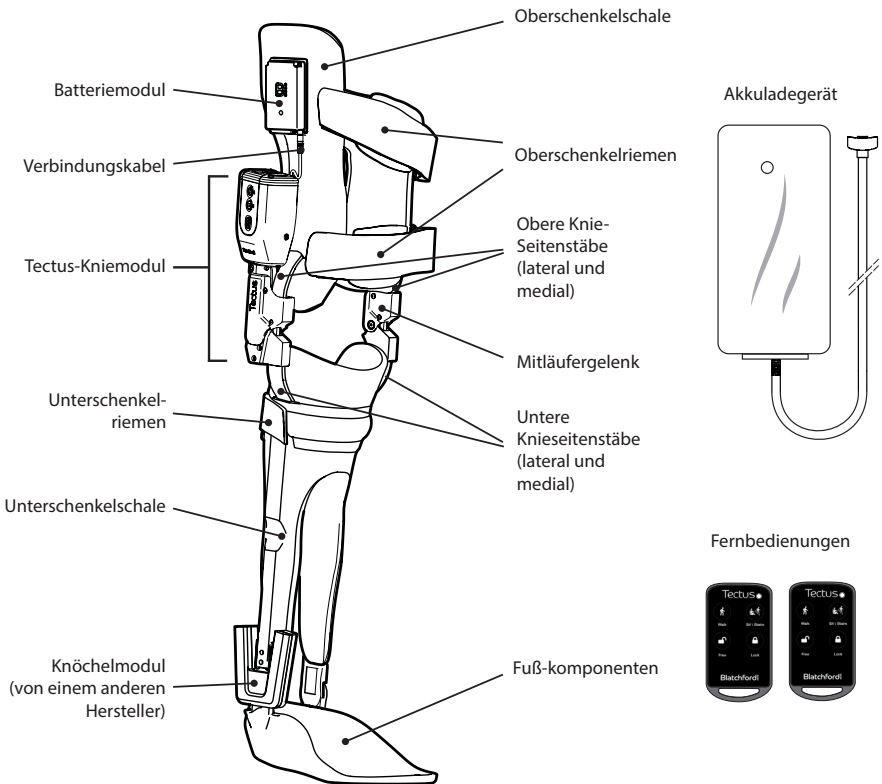

Hinweis... Zur Veranschaulichung ist nur das rechte Bein mit der Tectus-KAFO dargestellt.

**Tectus-Kniemodul
(rechtes Bein abgebildet)**

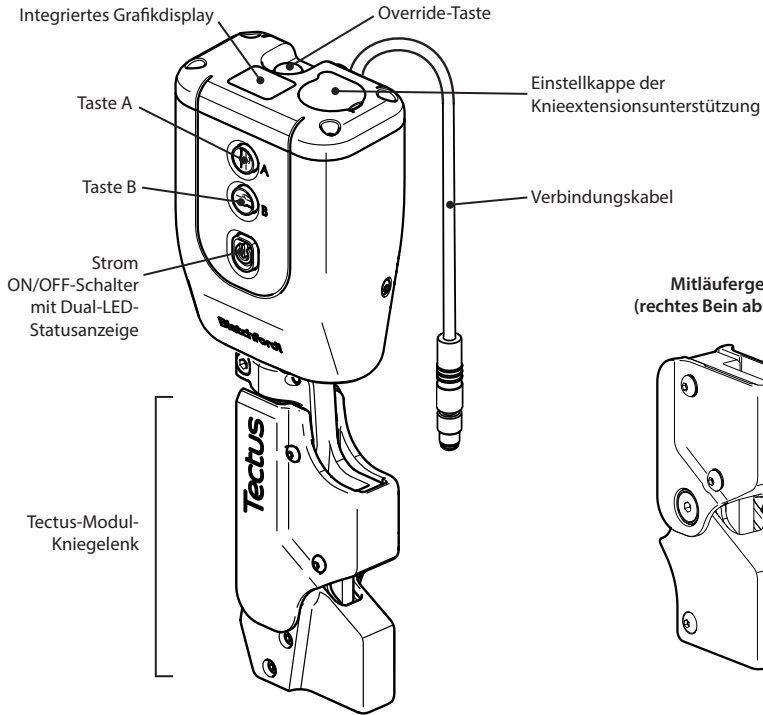

Batteriemodul

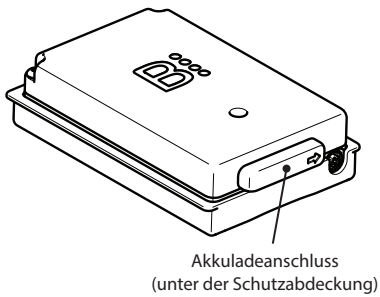

Knieseitenstäbe

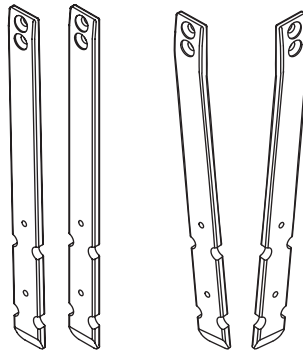

938467

4 Wichtige Punkte

Das mikroprozessorgesteuerte Produkt wird von dem Fachpersonal auf Ihre individuellen Gangbedürfnisse konfiguriert und passt sich in Echtzeit an Ihre aktuelle Bewegungssituation an.

Eine ON/OFF-Taste und zwei Drucktasten (A und B) am Produkt ermöglichen die lokale Steuerung durch verschiedene Tastenkombinationen. Siehe Abschnitt 10.5 *Moduswechsel am Produkt mit den Tectus-Modultasten A und/oder B*.

Sie können keine Anpassungen an der programmierten Leistung des Produktes vornehmen. Diese müssen von dem Fachpersonal durchgeführt werden. Das Produkt ermöglicht es Ihnen jedoch, den Betriebsmodus manuell über die 4-Tasten-Fernbedienung und/oder die Tasten A und B zu wechseln, um den Betrieb des Produkts an die jeweiligen Umstände anzupassen. Wenn Sie beispielsweise eine Treppe hinuntergehen möchten, wählen Sie den **Treppenmodus** kurz bevor Sie die Treppe hinuntergehen. Im **Treppenmodus** sorgt das Produkt für die notwendige zusätzliche Unterstützung, indem es den Flexionswiderstand erhöht. Informationen zur Bedienung des Produkts und zu den Betriebsmodi, die Ihnen zur Verfügung stehen, finden Sie in Abschnitt 10 *Bedienung des Tectus Kniemoduls*.

Eine Fernbedienung mit vier Tasten an einem Schlüsselband bietet Ihnen die Möglichkeit, zwischen den Betriebsmodi umzuschalten. Siehe Abschnitt 10.6 *Einschalten des Produkts mit Hilfe der Fernbedienung*.

Im Falle einer Störung der elektronischen oder hydraulischen Steuerung oder wenn der Akku vollständig entladen ist, schaltet das Produkt automatisch in den **Sicherheitsmodus**. In diesem **Sicherheitsmodus** kehrt das Produkt zu den vorprogrammierten Widerstandsparametern zurück und erlaubt nur eine eingeschränkte Funktionalität. Der normale Betrieb wird wieder aufgenommen, wenn das Produkt zum ersten Mal eingeschaltet wird, nachdem die Störung behoben oder der Akku wieder aufgeladen wurde. Siehe Abschnitt 5.1 *Anzeige für kritischen Service* und Abschnitt 7.3.2 *Verhalten bei niedrigem Akkustand*.

Das Produkt verfügt über eine mechanische Override-Taste, die eine Beugung des Knies (Knieflexion) erlaubt, während sie gedrückt wird. Siehe Abschnitt 10.8 *Mechanischer Override-Betrieb*.

5 Wartung

Die Tectus-KAFO muss nach dem Anpassen zu den folgenden Zeitpunkten routinemäßig überprüft werden:

2 Wochen	3 Monate	6 Monate	12 Monate	24 Monate
----------	----------	----------	-----------	-----------

Diese Inspektionen müssen von kompetentem Personal gemäß dem bei Blatchford ACS erhältlichen Plan für Routineinspektionen durchgeführt werden.



Die Durchführung von Routineinspektionen gemäß dem vorgeschriebenen Wartungsplan und die Benachrichtigung von Blatchford über die Ergebnisse sind notwendig, um die Voraussetzungen für die Garantie zu erfüllen.

Führen Sie selbst an diesem Produkt keine Wartungsarbeiten durch. Senden Sie das Produkt zur Wartung stattdessen an das Fachpersonal/den Dienstleister. Wenn sich das Produkt noch in der Garantiezeit befindet, werden wir Ihnen leihweise eine andere Knieeinheit zur Verfügung stellen, während wir die Wartung durchführen. Das Leihprodukt und das nach der Wartung zurückgegebene Produkt müssen vor der Verwendung von dem Fachpersonal eingestellt werden.

Jegliche Veränderungen der Leistung des Geräts müssen dem Fachpersonal mitgeteilt werden.

Leistungsveränderungen können umfassen:

- Erhöhte oder verringerte Kniestufigkeit
- Instabilität

- Verringerte Knieunterstützung (freie Bewegung)
- Alle unbekanntenen Signaltöne, Warnleuchten, Bildschirmanzeigen oder Vibrationen des Produkts*
- Ungewöhnliche Geräusche

*Das Produkt vibriert, wenn sich die Betriebsmodi ändern. Das ist normal.



Das Produkt darf nicht selbst geölt werden, dies wird beim Service mit den entsprechenden Schmiermitteln durchgeführt.



WD40 oder andere Wasserdispergiermittel dürfen niemals auf bewegliche Teile des Produkts aufgetragen werden, um ungewöhnliche Geräusche, Quietschen oder schwergängige Gelenke zu beheben.

Überprüfen Sie das Produkt jedes Mal vor der Verwendung auf physische Schäden an der KAFO und auf:

- Abnutzungserscheinungen
- Hydraulische Leckage
- Sicherheit der Gelenkabdeckungen
- Sicherheit und Zustand der Riemen

Wechseln Sie die Batterie der Fernbedienung entweder alle sechs Monate oder:

- wenn das Umschalten zwischen den Knieschaltmodi unbeständig wird, oder
- wenn bei der Betätigung einer Taste die LED der Fernbedienung nicht aufleuchtet

Siehe Abschnitt 5.4 **Austausch der Batterie in der Fernbedienung**. Wenn Sie diesen Vorgang aus irgendeinem Grund nicht durchführen können, kontaktieren Sie das Fachpersonal oder den Dienstleister, damit dieses/r den Austausch der Batterie für Sie durchführen kann.

5.1 Anzeige für kritischen Service

Falls das Produkt eine Störung feststellt, wird die Anzeige für den kritischen Service aktiviert und blinkt auf dem Bildschirm des Produkts (siehe Abbildung). Das Produkt versucht, in den **Sicherheitsmodus** zu wechseln, mit höherem Knieflexions- und Extensionswiderstand als normal. Gleichzeitig beginnt die Taste B rot zu blinken, bis die Störung behoben ist.

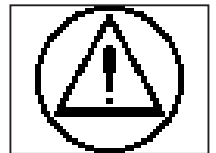

In diesem **Sicherheitsmodus** können Sie das Knie langsam strecken oder beugen, damit Sie sich in eine sichere Position begeben können, um das Produkt abzunehmen.



Wenn der Sicherheitsmodus aus irgendeinem Grund nicht ausgelöst wird, müssen Sie die Verwendung des Produkts sofort einstellen.

Wenn eine Einstellung des Kniewinkels erforderlich ist, kann das Produkt durch Betätigen der Override-Taste frei gebeugt oder gestreckt werden, siehe Abschnitt 10.8.



ACHTUNG! Verwenden Sie die Override-Taste nur, wenn es sicher ist.



Bei einer Störung des Produkts, die auch durch einen Hard-Reset (siehe Abschnitt 5.2) nicht behoben werden kann, oder wenn die Anzeige für kritischen Service angezeigt wird, müssen Sie sich so schnell wie möglich an das Fachpersonal wenden und dürfen das Produkt nicht verwenden, bis die Störung behoben und/oder der erforderliche Service durchgeführt wurde.

Die Anzeige für kritischen Service blinkt kontinuierlich und das Knie bleibt in diesem Modus, bis die Störung behoben ist. Wenn das Produkt ausgeschaltet wird, während die Anzeige für kritischen Service aktiviert ist, erlischt sie. Wenn Sie das Produkt jedoch das nächste Mal einschalten, beginnt die Anzeige für kritischen Service erneut zu blinken, und zwar so lange, bis die Störung behoben ist.

5.2 Hard-Reset

Im Falle einer geringfügigen und nicht wiederkehrenden Störung kann ein Hard-Reset durchgeführt werden, damit sich das Produkt selbst wiederherstellen kann. Um einen Hard-Reset durchzuführen, muss das Produkt über die ON/OFF-Taste auf dem Kniemodul aus- und wieder eingeschaltet werden.



Wenn die Störung weiterhin besteht, wenden Sie sich an das Fachpersonal.

5.3 Reinigung

Blatchford empfiehlt, das Produkt täglich zu reinigen. Reinigen Sie die äußeren Oberflächen mit einem feuchten Tuch und milder Seife. Verwenden Sie KEINE aggressiven Reiniger. Nicht in der Waschmaschine waschen/trocknen oder einen Wasserschlauch, Hochdruckreiniger/Trockner verwenden.

Es darf kein Wasser/keine Flüssigkeit in die Ladebuchse gelangen. Trocknen Sie das Produkt vor dem Gebrauch sorgfältig.

5.4 Austausch der Batterie in der Fernbedienung

Die Fernbedienung wird mit einer CR-2032-Knopfbatterie betrieben. Ein Austausch ist alle sechs Monate erforderlich oder wenn das Umschalten zwischen den Kniemodi nicht mehr funktioniert oder wenn die LED der Fernbedienung nicht mehr bei jedem Tastendruck aufleuchtet.



Legen Sie die Fernbedienung mit dem Batterie-fachdeckel nach oben auf eine ebene Fläche.



Entfernen Sie beide Schrauben mit einem geeigneten Kreuzschlitzschraubendreher und legen Sie beiseite.



Hebeln Sie die Abdeckung mit einem geeigneten Schlitzschraubendreher nur von der Seite der Befestigung am Schlüsselband der Fernbedienung her auf, um eine Beschädigung der Abdichtung zu vermeiden.



Entfernen Sie die entladene Batterie und entsorgen Sie sie gemäß den lokalen Recyclingvorschriften.



Batterien müssen außerhalb der Reichweite von Kindern und Haustieren aufbewahrt werden. Im Falle eines Verschluckens einen Arzt aufsuchen.



Überprüfen Sie nach dem Auswechseln der Batterie die Funktionalität der Fernbedienung, indem Sie alle Tasten für den gewünschten Kniemodus einstellen und prüfen, ob die LED an der Fernbedienung nach jedem Tastendruck einmal aufleuchtet.

6 Verwendungseinschränkungen

Heben von Lasten

Das Gewicht und die Mobilität des Anwenders werden von den angegebenen Grenzwerten bestimmt.

In einer lokalen Risikobewertung sollte ermittelt werden, wie viel Last der Anwender tragen kann. Bei der Einschätzung muss berücksichtigt werden, dass sich das Tragen von Lasten auf die Körperhaltung und die Fähigkeit auswirken kann, die erforderlichen Parameter zu erfüllen, um das Knie aus der Standphase zu lösen.

Das kombinierte Benutzergewicht und die Hebelast dürfen keinesfalls 100 kg überschreiten.

Umwelt

Vermeiden Sie es, die Tectus-KAFO korrosiven Elementen wie Wasser, Säuren und anderen Flüssigkeiten auszusetzen. Außerdem abrasive Umgebungen vermeiden, wie beispielsweise Sand, da dies zu vorzeitigem Verschleiß führen kann.

Hinweis... Nur das Kniemodul und der Akku sind wasserdicht nach Schutzart IP54.















Das Produkt ist ausschließlich für die Verwendung zwischen -10 °C und 50 °C vorgesehen.



Für den Außenbereich geeignet

7 Laden des Akkus

7.1 Sicherheitshinweise zum Aufladen des Akkus

-  Schließen Sie das Ladegerät niemals an das Produkt an, während Sie es noch tragen.
-  Der Akku sollte nur bei Temperaturen zwischen 0 °C und 35 °C geladen werden.
-  Das Ladegerät eignet sich für Steckdosen mit einer Spannung von 100 V bis 240 V AC, 50/60 Hz.
-  Laden Sie den Akku des Produkts nur mit dem mitgelieferten Ladegerät und Ladekabel auf. Verwenden Sie dieses Ladegerät nicht zum Laden anderer Produkte.
-  Vergewissern Sie sich, dass der passende, länderspezifische Netzadapterstecker am Ladegerät angebracht ist. Stecken Sie den Netzstecker niemals in eine inkompatible Steckdose.
-  Vergewissern Sie sich vor dem Laden, dass die Ladeflächen trocken und frei von Verunreinigungen und Ablagerungen sind, da dies den Ladevorgang beeinträchtigen kann.
-  Wenn Sie während des Ladevorgangs ein ungewöhnliches Geräusch oder einen ungewöhnlichen Geruch wahrnehmen, trennen Sie das Ladegerät und schalten Sie sowohl das Ladegerät als auch das Kniemodul aus. Melden Sie dieses Problem dem Fachpersonal.
-  Die Anschlüsse des Akkumoduls und des Akkuladegeräts enthalten starke Magnete. Halten Sie immer einen Sicherheitsabstand (mindestens 10 cm) zwischen diesen Magneten und allen Gegenständen ein, die durch Magnetismus beeinflusst werden können, wie z. B. Uhren, Herzschrittmacher, Bankkarten oder alle magnetischen Speichermedien.
-  Achten Sie darauf, dass kein eisenhaltiges Material an den Ladeflächen anhaftet.
-  Nehmen Sie den Adapterstecker oder das Akkuladegerät nicht ab.
-  Ersetzen Sie beschädigte Adapterstecker oder Akkuladegeräte sofort durch Ersatzteile von Blatchford.
-  Während des Ladevorgangs schaltet sich das Produkt ab. Nach dem Aufladen muss das Produkt über die ON/OFF-Taste an der Außenseite des Tectus-Kniemoduls eingeschaltet werden.
-  Nehmen Sie die Akkus nicht heraus. Sie können nicht selbst ausgetauscht werden und werden bei Bedarf bei einer Routinekontrolle ersetzt.
-  Wenn das Produkt Temperaturen von weniger als -10 °C ausgesetzt war, muss es zur Überprüfung auf mögliche Schäden am Akku zu Blatchford zurückgeschickt werden.

7.2 Vor dem Aufladen



Das Produkt darf nicht aufgeladen werden, während es getragen wird; nehmen Sie die Tectus-KAFO vor dem Aufladen ab. Ziehen Sie das Produkt nicht an, während es an das Ladegerät angeschlossen ist.

Prüfen Sie vor dem Gebrauch immer den Ladezustand des Akkus, um sicherzustellen, dass er für die täglichen Aktivitäten ausreichend geladen ist. Bei regelmäßiger Nutzung wird empfohlen, das Produkt täglich aufzuladen.

Es wird empfohlen, das Produkt in den **Arretierungsmodus** zu schalten und die Tectus-KAFO vor dem Aufladen in eine horizontale Position (auf eine flache Oberfläche oder den Boden) zu legen, mit dem Kniemodul nach oben und mit 5 Grad Knieflexion, damit sie sicher steht und nicht umkippt.

Hinweis... Sobald das Ladegerät angeschlossen ist, schaltet sich das Kniemodul automatisch aus.

7.3 Anzeige des Akkustands auf dem Bildschirm

7.3.1 Normale Anzeigen

Die Akkustandsanzeige erscheint für 5 Sekunden an der Seite des integrierten Grafikdisplays:

- Während der Modusumschaltung.
- Halten Sie die Tasten A und B gemeinsam gedrückt.

Die folgenden Akkustandsanzeigen sind verfügbar:

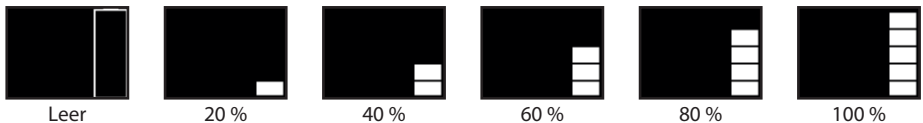

7.3.2 Verhalten bei niedrigem Akkustand

Warnung bei niedrigem Akkustand

Das Produkt warnt Sie, wenn der angezeigte Akkuladestand auf 20 % sinkt, indem es zwei kurze hohe Töne abgibt und zusätzlich das Warnsymbol gefolgt von einem Balken auf dem Grafikdisplay anzeigt. Diese Warnung wird alle 10 Minuten und/oder beim Drücken einer beliebigen Taste auf dem Produkt wiederholt, bis der Ladezustand des Akkus den kritisch niedrigen Wert erreicht.



Warnung bei kritischem Akkustand

Ein kritisch niedriger Akkustand wird durch das Blinken des Warnsymbols und einen langen, hohen Signalton angezeigt. Das Produkt wechselt in den **Sicherheitsmodus**, entsprechend der Beschreibung in Abschnitt 5.1 *Anzeige für kritischen Service*.



Wenn die Warnung für einen kritischen Akkustand angezeigt wird, müssen Sie die Verwendung des Produkts einstellen und dürfen es nicht wieder verwenden, bis es wieder aufgeladen ist.

7.3.3 Nach Anschluss des Akkuladegeräts keine Anzeige

Wenn nach dem Anschließen und Einschalten des Ladegeräts das Grafikdisplay des Produkts nichts anzeigt, ist der Akku möglicherweise vollständig entladen. Lassen Sie das Akkuladegerät mindestens 15 Minuten lang angeschlossen und überprüfen Sie den Ladezustand, indem Sie das Ladegerät ab- und wieder anstecken.

7.4 Anschließen und Trennen des Ladegeräts

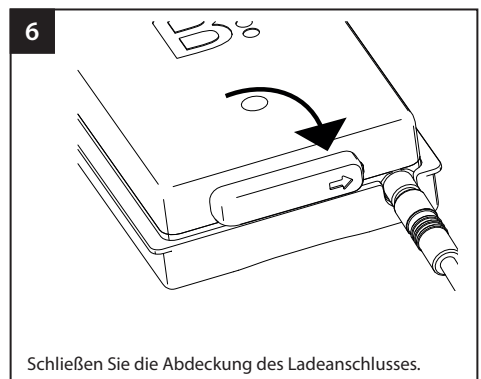
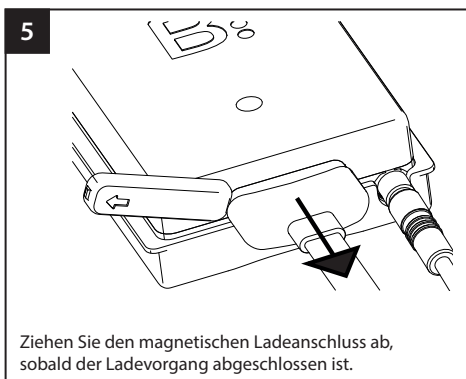
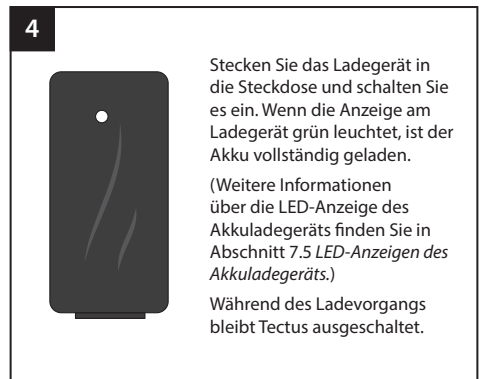
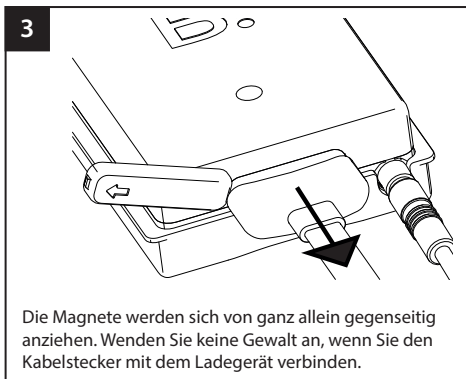
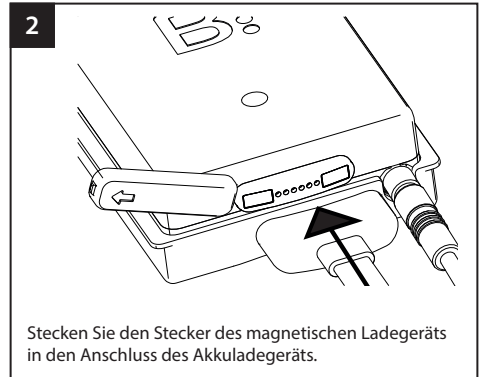
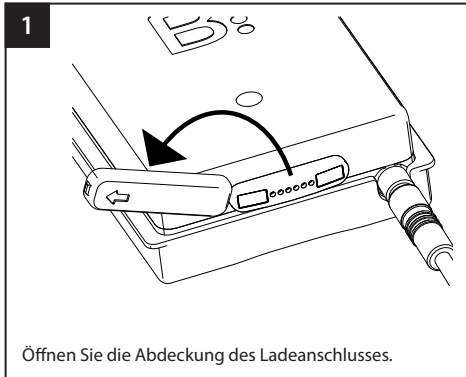

7.5 LED-Anzeigen des Akkuladegeräts

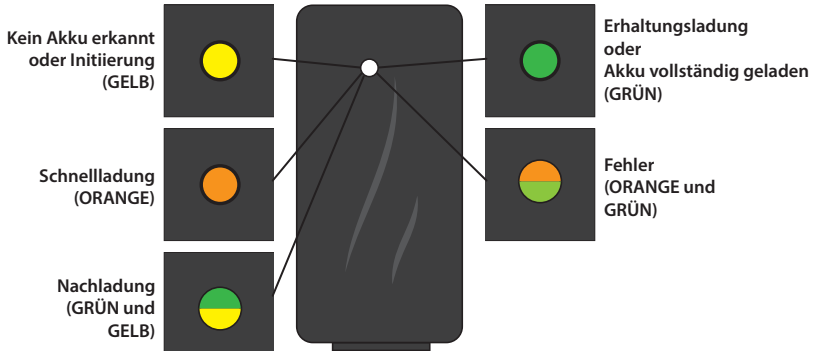

Hinweis... Weitere Informationen finden Sie auf der Rückseite des Akkulademoduls und in der mit dem Ladegerät gelieferten Anleitung.



Start-Sequenz

Schalten Sie das Ladegerät bei eingestecktem Netzstecker und angeschlossenem Produkt an der Steckdose ein. Die LED des Ladegeräts leuchtet in der folgenden Farbfolge etwa 10 Sekunden lang auf, um anzuzeigen, dass das Produkt geladen wird.

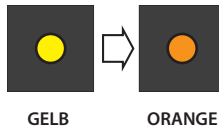

7.6 Referenzzeiten für das Aufladen und den Betrieb

Montageverfahren	Zeit
Zeit zum vollständigen Aufladen des Akkus (aus dem vollständig entladenen Zustand).	Ca. 2 Stunden
Mindestladezeit vor der Benutzung (aus dem vollständig entladenen Zustand).	Mindestens 1 Stunde
Maximale Akkulaufzeit, ausgehend von einer vollen Ladung, bei kontinuierlichem Betrieb des Produkts, d. h. bei ununterbrochenem Gehen. (abhängig von Betriebstemperaturen)	18 Stunden (siehe Hinweise i und ii)

- Hinweise:
- i) Um die maximale Betriebszeit mit einer Akkuladung zu erreichen, sollten Sie das Produkt ausschalten, wenn es nicht benutzt wird.
 - ii) Die Betriebszeit des Produkts kann sich bei niedrigen Umgebungstemperaturen oder aufgrund von Akkualterung verkürzen.

8 Wie Sie die Tectus-KAFO an- und ablegen

8.1 Anlegen der Tectus-KAFO

Hinweise: i) Laden Sie das Produkt vor dem Anlegen. (Siehe Abschnitt 7 *Laden des Akkus*.)

ii) Prüfen Sie das Produkt täglich auf Anzeichen von Verschleiß oder Schäden, die die Sicherheit oder Funktion des Produkts beeinträchtigen könnten. Wenn etwas Ungewöhnliches bemerkt wird, bitten Sie das Fachpersonal um Rat.

1. Alle Verschlussriemen vollständig lösen und öffnen, sodass die Öffnungen in der Hülle sichtbar sind.
 2. Den Schuh abnehmen.
 3. Sitzen Sie an der Vorderkante eines Stuhls.
 4. Schalten Sie das Produkt ein. (Siehe Abschnitt 9.)
 5. Wenn Sie das Produkt waagrecht liegend einschalten, sollte es sich nach dem Einschalten im **freien** Modus befinden. Ist dies nicht der Fall, versetzen Sie das Produkt über die Fernbedienung oder die Modultasten in den **freien** Modus.
 6. Die Tectus-KAFO am Knie beugen.
 7. Das Bein leicht strecken und den Oberschenkel in die Oberschenkelschale legen.
 8. Den Fuß in die Fußkomponente legen, dabei zuerst die Ferse positionieren und dann den Unterschenkel in die Unterschenkelhülle legen.
 9. Befestigen Sie alle Riemen. Nicht zu fest festziehen.
 10. Überprüfen Sie den Sitz der Orthese auf Komfort. (Ändern Sie diese nach Bedarf, z. B. durch entsprechende Schnittlinien.)
 11. Ziehen Sie den Schuh über die Fußkomponente. (Manche Anwender ziehen die Tectus-KAFO lieber an, wenn der Schuh bereits an seinem Platz ist.)
 12. Das Produkt auf den **Gehmodus** stellen und aufstehen (bei Bedarf an einem zweiten Stuhl abstützen) und alle Verschlüsse/Riemen nach Bedarf anpassen.
 13. Beim Tragen über Kleidung sicherstellen, dass diese sauber gefaltet ist und nicht drückt. Beim Tragen unter Kleidung (z. B. Kleid, Rock, weite Hose) sollte eine Socke oder dünne Unterkleidung getragen werden, die das gesamte Bein bedeckt.
-  **Um Schäden an der Kleidung zu vermeiden, sicherstellen, dass keine Kleidung zwischen den beweglichen Teilen des Produkts eingeklemmt wird.**
14. Das Produkt auf **Sitzmodus** stellen und wieder vorsichtig hinsetzen.
 15. Das Produkt auf den **freien** Modus stellen und das Knie sanft beugen und strecken, um zu bestätigen, dass die Tectus-KAFO im gesamten Bewegungsbereich bequem sitzt.
 16. Stellen Sie das Produkt vor dem Aufstehen wieder in den **Gehmodus**.

8.2 Ablegen der Tectus-KAFO

1. Stellen Sie das Produkt in den *Sitzmodus*.
2. Auf der vorderen Hälfte eines Stuhles hinsetzen (bei Bedarf an einem weiteren Stuhl abstützen).
3. Stellen Sie das Produkt in den *freien* Modus.
4. Den Schuh abnehmen.
5. Alle Befestigungsriemen öffnen.
6. Die Tectus-KAFO abnehmen.
7. Die Tectus-KAFO in 5 Grad Knieflexion bringen und den *Arretierungsmodus* am Produkt aktivieren.
8. Das Produkt ausschalten.
9. Die Tectus-KAFO in horizontaler Position ablegen (auf eine ebene Oberfläche oder den Boden), mit nach oben zeigendem Kniemodul und 5 Grad Knieflexion, sodass sie sicher liegt und nicht rollen kann.

Hinweis... Wir empfehlen, das Produkt nach jeder Verwendung aufzuladen.



Die Gliedmaße, an der die Tectus-KAFO getragen wird, muss regelmäßig auf Hautreizungen, Gewebeschäden, Druckgeschwüre oder Unwohlsein untersucht werden. Suchen Sie bei solchen Symptomen das Fachpersonal auf.

9 Ein- und Ausschalten des Produkts

Das Produkt wird über den ON/OFF-Schalter am Produkt ein- bzw. ausgeschaltet, es gibt keinen ON/OFF-Schalter auf der Fernbedienung.

Einschalten

Um das Produkt einzuschalten, halten Sie den ON/OFF-Schalter gedrückt, bis die LED grün leuchtet. Während der Startsequenz ertönen kurze Signaltöne und Vibrationen; wenn diese aufhören, lassen Sie den Schalter los.

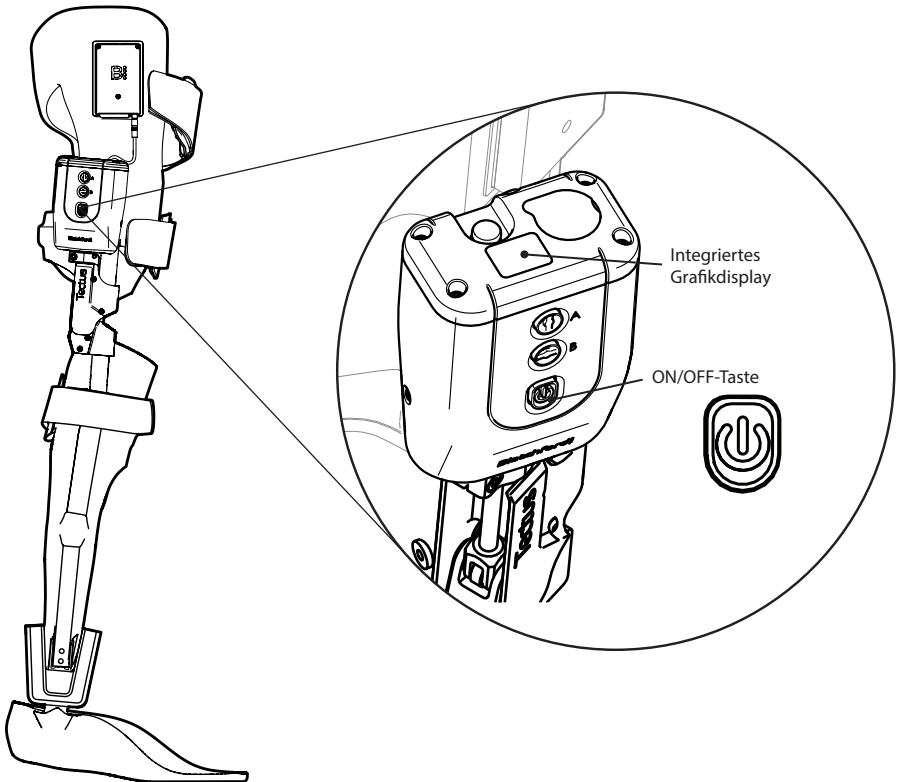

Ausschalten

Um die Abschaltsequenz einzuleiten, halten Sie den ON/OFF-Schalter gedrückt, bis zwei kurze Signaltöne mit zwei kurzen Vibrationen ertönen, und lassen Sie diesen dann los.



Start-Sequenz

Das Einschalten löst die automatische Start-Sequenz aus, bei der sich die LED- und Grafikanzeige ändert, Signaltöne ertönen und das Produkt wie abgebildet vibriert. Die Sequenz dauert etwa 4 Sekunden.

! Verwenden Sie das Produkt nicht, wenn die **BLAUE LED** während und nach Abschluss der Start-Sequenz weiter blinkt. Dies zeigt an, dass die Programmierung des Produkts zuvor nicht abgeschlossen wurde. Kontaktieren Sie das Fachpersonal, bevor Sie das Produkt verwenden.

Das Produkt ist eingeschaltet und einsatzbereit, wenn der Standardmodus **Frei/Gehen** (je nach Ausrichtung des Produkts beim Einschalten) auf dem integrierten Grafikdisplay angezeigt wird (siehe rechts dargestellte Sequenz).

Hinweis... Das Display wechselt nach 5 Sekunden Inaktivität in den Ruhezustand (das Display zeigt nichts an), wird aber nach jedem Wechsel des Benutzermodus reaktiviert, der entweder durch die Tasten A/B am Produkt oder die Tasten an der Fernbedienung veranlasst wird.

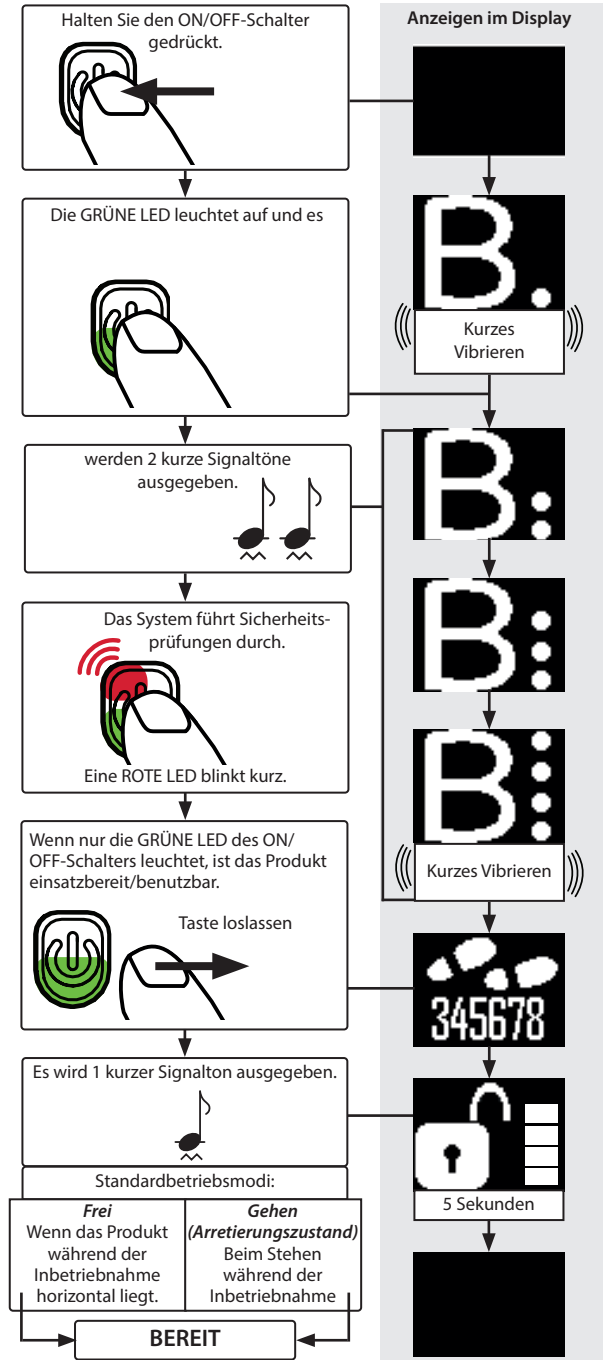

10 Bedienung des Tectus Kniemoduls

10.1 Anwendermodi

Das Produkt verfügt über die folgenden vom Anwender wählbaren Betriebsmodi:

- *Gehen*
- *Sitzen*
- *Stufen*
- *Arretierung*
- *Frei*
- *Lautlos*

Das Produkt kann automatisch in die folgenden Modi wechseln:

- *Kritischer Service*
- *Sicher*

Das Produkt verfügt über den folgenden, nur vom Fachpersonal wählbaren Betriebsmodus:

- *Training*

10.2 Sicherheit beim Umschalten zwischen den Anwender-Modi

10.2.1 Standard-Anwendermodus

Das Produkt schaltet nach dem Einschalten standardmäßig in den Modus „*Frei*“, wenn der Anwender sitzt, oder in den Modus „*Arretieren*“ oder „*Gehen*“, wenn der Anwender steht. Während der Inbetriebnahme ist der *freie* Modus nur für das Anlegen des Produkts vorgesehen. Bevor Sie nach dem Anlegen des Produkts aufstehen, sollten Sie einen anderen Modus wählen (in der Regel den *Gehmodus*).

10.2.2 Sicherheitseinschränkungen beim Umschalten des Modus durch den Anwender

Das Produkt erlaubt es nicht, in den Modus „*Frei*“ zu wechseln, wenn der Anwender mit arretiertem Knie geht, eine Treppe hinuntergeht oder steht. Dies geschieht aus Sicherheitsgründen, da ein plötzlicher Verlust der Unterstützung ein erhebliches Sturzrisiko darstellt. Daher werden die folgenden Modus-Umschaltkombinationen vom Produkt nicht ausgeführt:

Gehmodus in den *Freien Modus*

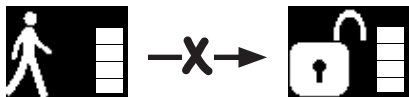

Treppenmodus in den *Sitzmodus*

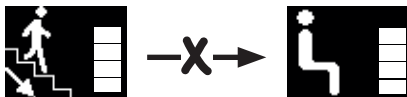

Treppenmodus in den *Freien Modus*

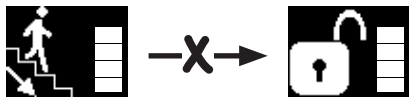

Sitzmodus in den *Treppenmodus*

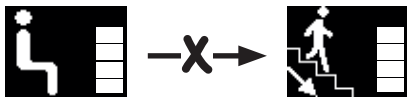

Arretierungsmodus in den *Freien Modus*

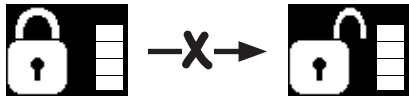

Freier Modus in den *Treppenmodus*

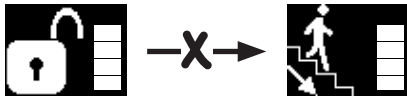

10.2.3 Warnung vor Überlastung des Produkts

In sehr seltenen Fällen und unter besonderen Umständen kann das Produkt einen schnellen Signalton und einen Vibrationsalarm für bis zu 15 Sekunden erzeugen. Das bedeutet, dass das Produkt überlastet ist, weil es nicht wie vorgesehen verwendet wurde oder ein interner Fehler vorliegt.

Gründe für eine solche Warnung

Wenn Sie (oder das Produkt selbst) erfolgreich Abhilfemaßnahmen ergreifen, um den Überlastungszustand vor Ablauf der 15-sekündigen Alarmzeit zu beseitigen, wird der Alarm gestoppt und das Produkt nimmt seinen normalen Betrieb wieder auf.



Wenn Sie (oder das Produkt selbst) keine erfolgreichen Abhilfemaßnahmen ergreifen, um den Überlastungszustand vor Ablauf der 15-sekündigen Alarmzeit zu beseitigen, interpretiert das Produkt dies als eine Fehlersituation und schaltet automatisch in den **Sicherheitsmodus**.





















Auftreten und Vermeiden von Überlastungen des Produkts

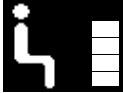

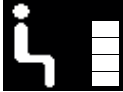







Die folgende Tabelle fasst die Szenarien zusammen, in denen das Produkt überlastet werden könnte, sowie die möglichen Abhilfemaßnahmen.





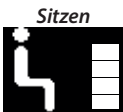

Auftreten des Alarms	Grund	Abhilfemaßnahme
Während der Modumschaltung	Sie haben möglicherweise versucht, zwischen den Benutzermodi zu wechseln, als die vorherige Tätigkeit noch nicht vollständig abgeschlossen war und das Hydrauliksystem noch nicht bereit war, sich auf die neuen Parameter einzustellen.	Versuchen Sie, die Last auf das Produkt zu reduzieren, bis es den Befehl zur Modumschaltung ausführen kann. Das schnelle Piepen sollte sofort aufhören, um anzuzeigen, dass der normale Betrieb wieder aufgenommen wurde. Planen Sie immer ausreichend Zeit ein, damit das Produkt auf Befehle zum Umschalten des Modus reagieren kann.
Während des Hinsetzens	Während des Hinsetzens schaltet das Produkt bei etwa 45° der Bewegung automatisch auf einen niedrigeren Widerstand um. Wenn Sie versuchen, sich zu schnell und gewaltsam hinzusetzen, überlastet dies das Hydrauliksystem beim Umschalten des Modus.	Versuchen Sie, die Belastung auf das Produkt zu reduzieren, bis es in den Freien Modus wechseln kann. Befolgen Sie die Anweisungen des Fachpersonals in Bezug auf die richtige Art und Weise und Geschwindigkeit des Hinsetzens, während Sie das Produkt tragen.
Im Störfall	Wenn die Abhilfemaßnahme das Problem nicht innerhalb der 15-sekündigen Alarmzeit behebt, geht das Produkt von einer Störung aus, kehrt in den Sicherheitsmodus zurück, und die Anzeige für kritischen Service erscheint auf dem Bildschirm des Produkts.	Lesen Sie den Abschnitt 5.1 Anzeige für kritischen Service über den Umgang mit einer Störung sowie die Beschreibung des Sicherheitsmodus .

10.3 Aktivitäten und zugehörige Benutzermodi

Aktivität	Aktivierter und angezeigter Modus	Funktions- und Verfahrensanweisung
<p>Gehen</p> 	<p><i>Gehen</i></p> 	<p>Sorgt automatisch für Unterstützung während des Stands und der Auslösung während der Schwungphase. Obwohl nicht mikroprozessorgesteuert, ist die Extensionsunterstützung für das Knie immer aktiv.</p>
<p>Stehen</p> 	<p><i>Gehen</i></p>  <p><i>Arretierung</i></p> 	<p>Wenn Sie im <i>Gehmodus</i> stillstehen, werden Sie unterstützt. Aus dem Stand heraus erkennt das Produkt jede Bewegung, wie z. B. einen Schritt vorwärts oder rückwärts, und bietet entsprechend Unterstützung.</p> <p>Um eine angemessene Unterstützung zu bieten, empfiehlt es sich, den <i>Arretierungsmodus</i> zu verwenden, wenn Sie längere Zeit stehen (z. B. in einer Warteschlange) oder in einer Umgebung, in der Ihr Gleichgewicht beeinträchtigt sein kann (z. B. in einer Menschenmenge).</p> <p>Hinweis... Der <i>Arretierungsmodus</i> ist ein fester Modus, in dem das Produkt Bewegungen nicht erfasst. Der <i>Arretierungsmodus</i> muss manuell eingestellt und freigegeben werden.</p>
<p>Rückwärtsgehen</p> 	<p><i>Gehen</i></p> 	<p>Wenn Sie im Gehmodus rückwärts treten oder sich nach hinten lehnen, geht das Produkt in einen arretierten Zustand namens „Backstep“ über. Dies gibt Ihnen Unterstützung, damit Sie Ihr Gleichgewicht finden.</p> <p>Hinweis... „<i>Backstep</i>“ ist ein Zustand innerhalb des <i>Gehmodus</i> und ist nicht dasselbe wie der vom Anwender wählbare Arretierungsmodus.</p> <p>Wenn der <i>Trainingsmodus</i> aktiviert ist, zeigt das Produkt den Wechsel in den <i>Backstep-Zustand</i> durch einen langen, hohen Signalton und eine Vibration an.</p> <p>Das Produkt schaltet erst dann wieder in den <i>Arretierungszustand</i> um, wenn Sie in die stehende Position zurückgekehrt sind und diese mindestens zwei Sekunden lang beibehalten haben. Wenn der <i>Trainingsmodus</i> aktiviert ist, wird dies durch zwei Signaltöne und Vibrationen des Produkts angezeigt.</p>
<p>Arretierung</p>	<p><i>Arretierung</i></p> 	<p>Das Knie ist gegen Flexion arretiert, kann aber frei gestreckt werden bis die maximale Extension erreicht ist.</p> <p>Der <i>Arretierungsmodus</i> bleibt so lange aktiv, bis ein anderer Modus gewählt oder die mechanische Überbrückungstaste gedrückt wird.</p>
<p>Frei</p>	<p><i>Frei</i></p> 	<p>Das Produkt bietet einen minimalen Widerstand bei der Flexion und ein Minimum an Extensionsunterstützung bei der Extension.</p> <p>Der <i>Freie</i> Modus bleibt aktiv, bis manuell ein anderer Modus ausgewählt wird.</p> <p> Dieser Modus bietet keine ausreichende Unterstützung zum Stehen.</p>

Aktivität	Aktivierter und angezeigter Modus	Funktions- und Verfahrensanweisung
<p>Hinsetzen</p> 	<p><i>Sitzen</i></p> 	<p>Der fixierte Widerstand am Knie bietet Unterstützung bei der Bewegung in eine sitzende Position. Die Geometrie des Moduls ermöglicht eine hohe Yielding-Funktionalität.</p> <p>Zum Sitzen müssen Sie den Sitzmodus manuell über die Schalttasten am Produkt oder auf der Fernbedienung aktivieren.</p> <p>Sie müssen sich Ihrer Umgebung bewusst sein, bevor Sie sich hinsetzen. Belasten Sie beim Hinsetzen beide Beine gleichmäßig. Beugen Sie sich an der Taille nach vorne, drücken Sie das Gesäß nach hinten, legen Sie die Hände auf die Armlehnen (falls vorhanden), winkeln Sie die Beine an und setzen Sie sich dann mit einer gleichmäßigen Bewegung hin.</p>
<p>Sitzen</p> 	<p><i>Sitzen</i></p>  <p><i>Frei</i></p> 	<p>Im Sitzmodus schaltet das Produkt 2 Sekunden nach Erreichen der Ruheposition automatisch in den freien Modus, um bei Bedarf eine Anpassung der Gliedmaßenposition im Sitzen zu ermöglichen.</p> <p>Hinweis... Das Produkt wird in diesem Freien Modus gestartet, wenn Sie den Startvorgang im Sitzen ausführen.</p> <p>Im Sitzmodus erkennt das Produkt, wenn Sie versuchen, aufzustehen, und blockiert die Flexion beim Aufstehen, so dass Sie sich erst wieder hinsetzen können, wenn entweder das Bein vollständig gestreckt ist oder die Override-Taste gedrückt wird.</p>
<p>Aufstehen zum Gehen</p> 	<p><i>Sitzen</i></p> 	<p>Im Sitzmodus erkennt das Produkt, wenn Sie versuchen, aufzustehen und zu gehen, und wechselt automatisch in den Gehmodus.</p> <p>Stellen Sie die Füße zum Aufstehen gleichmäßig auf, bewegen Sie den Oberkörper nach vorne und richten Sie sich mit Hilfe der Arme auf. Versuchen Sie, die Orthese zu belasten und mit dem Gehen zu beginnen.</p> <p>⚠️ Wenn Sie die Bewegung nicht abschließen und versuchen, sich wieder hinzusetzen, arretiert das Produkt die Flexion.</p>
<p>Treppen hinaufgehen</p> 	<p><i>Arretierung</i></p> 	<p>⚠️ Aus Sicherheitsgründen müssen Sie manuell in den Arretierungsmodus wechseln, bevor Sie eine Treppe hinaufsteigen.</p> <p>⚠️ Wenn möglich, müssen immer Handläufe verwendet werden.</p> <p>Im Arretierungsmodus gibt das Knie nicht nach (allerdings kann es gestreckt werden), so dass eine Treppe mit der gesunden Extremität hinaufgegangen werden sollte, also mit einem „Stufe-für-Stufe“-Gang.</p>

Aktivität	Aktivierter und angezeigter Modus	Funktions- und Verfahrensanweisung
<p>Treppen hinabsteigen</p> 	<p><i>Stufen</i></p>  <p><i>Arretierung</i></p> 	<p> Im <i>Treppenmodus</i> dürfen Sie nicht versuchen, eine Treppe mit dem alternierenden Gang hinunterzusteigen, bevor Sie nicht eine angemessene Physiotherapie und ein überwachtes Training abgeschlossen haben, das von dem Fachpersonal bestätigt wurde!</p> <p> Gehen Sie Treppen immer mit Vorsicht an und seien Sie sich Ihrer Umgebung bewusst.</p> <p> Wenn möglich, müssen immer Handläufe verwendet werden.</p> <p> Für den Treppenabstieg muss entweder der <i>Treppenmodus</i> oder der <i>Arretierungsmodus</i> aktiviert werden, bevor der Abstieg begonnen wird, und sobald er ausgewählt wurde, dürfen Sie nicht in einen anderen Modus wechseln, bis der Treppenabstieg abgeschlossen ist.</p> <p>Der <i>Treppenmodus</i> bietet eine angemessene Unterstützung für den alternierenden Abstieg mit programmiertem Flexionswiderstand in Kombination mit einer angemessenen Extensionsvorspannung.</p> <p>Hinweis... Stellen Sie nur die hintere Hälfte Ihres Fußes auf die Stufe, belasten Sie dann die Orthese und schieben Sie sie bis zur Knieflexion vor, treten Sie dann mit der gesunden Gliedmaße nach unten und lassen Sie die Knieflexion auf der Orthese zu.</p> <p>Im <i>Arretierungsmodus</i> gibt das Knie nicht nach, sondern ist in voller Extension blockiert. Daher sollten Sie einen Stufe-für-Stufe-Gang verwenden, bei dem Sie mit der arretierten Gliedmaße voran die Treppe hinuntergehen.</p>
<p>Einsteigen in ein Fahrzeug</p> 	<p><i>Sitzen</i></p> 	<p> Gehen Sie Fahrzeuge immer mit Vorsicht an und seien Sie sich Ihrer Umgebung bewusst.</p> <p>Um sich in das Fahrzeug zu setzen, müssen Sie den <i>Sitzmodus</i> aktivieren.</p> <p>Das Produkt geht in den <i>Zustand Freies Sitzen</i> über, wenn der Oberschenkel waagrecht ist (nicht identisch mit dem <i>Freien</i> Modus). So können Sie die Gliedmaße in eine bequeme und sichere Position manövrieren.</p> <p>Hinweis... Wenn der Oberschenkelwinkel nicht waagrecht ist, z. B. aufgrund des Winkels der Fahrzeugsitzfläche, geht das Produkt in den <i>Zustand zum Aufstehen</i> des <i>Sitzmodus</i> über und kann nur mit der mechanischen Override-Taste positioniert werden.</p>
<p>Aussteigen aus einem Fahrzeug</p> 	<p><i>Sitzen</i></p> 	<p>Vor dem Verlassen des Fahrzeugs sollten Sie sicherstellen, dass sich das Produkt im <i>Sitzmodus</i> befindet, damit Sie beim Verlassen des Fahrzeugs beim Übergang vom Sitzen zum Stehen unterstützt werden, sowie um sicherzustellen, dass das Produkt bereit ist, automatisch in den <i>Gehmodus</i> zu wechseln.</p>

Aktivität	Aktivierter und angezeigter Modus	Funktions- und Verfahrensanweisung
<p>Fahren</p> 	<p><i>Frei</i></p> 	<ul style="list-style-type: none">  Sie dürfen die Steuerung des Produkts oder die Fernbedienung nicht während der Fahrt bedienen.  Die Warnhinweise in diesem Dokument und alle nationalen Richtlinien müssen beachtet werden, wenn Sie erwägen, mit einer Tectus-KAFO Auto zu fahren.  Nur das nicht betroffene Bein darf zum Bedienen eines Fahrzeugs verwendet werden. <p>Für die Fahrt sollte das Produkt von Ihnen manuell über die Fernbedienung oder die Tasten des Produkts in den <i>Freien</i> Modus geschaltet werden.</p>
<p>Sicherheitsmodus</p>		<p>Das Produkt kehrt jedes Mal in den <i>Sicherheitsmodus</i> zurück, wenn eine Störung oder ein kritisch niedriger Akkustand festgestellt wird oder wenn die Warnzeit für den Service-Modus abgelaufen ist. Im <i>Sicherheitsmodus</i> schaltet das Produkt auf einen hohen Yielding-Knieflexionswiderstand um.</p> <p>Weitere Details finden sich in Abschnitt 5.1 <i>Anzeige für kritischen Service</i> und Abschnitt 7.3.2 <i>Verhalten bei niedrigem Akkustand</i>.</p>
<p>Kritischer Service</p>		<p>Hinweis... Der Trainingsmodus kann nur über den Zugriff auf die App durch Fachkräfte (Fachpersonal) aktiviert werden.</p> <p>Im <i>Trainingsmodus</i> werden akustische und vibrierende Hinweise gegeben, wenn sich der Betriebszustand im <i>Gehmodus</i> geändert hat, um Ihnen zu helfen, den Umgang mit dem Produkt zu erlernen.</p> <p>Wenn Sie z. B. den ersten Schritt aus dem Stand machen, um das <i>Rückwärtsgehen</i> zu aktivieren, gibt das Produkt einen langen Signalton ab und vibriert, um zu bestätigen, dass das <i>Rückwärtsgehen</i> ausgewählt wurde. Wenn Sie aufhören zu gehen und stehen bleiben, gibt das Produkt zwei kurze Töne ab und vibriert, um zu bestätigen, dass der <i>Arretiermodus</i> ausgewählt wurde.</p>
<p>Training</p>	<p><i>Training</i></p>	









10.4 Bedienvorgänge und Anzeigen des Produkts

Bedienung der Produkt- und der Fernbedienungstasten

Das Produkt wird manuell bedient, indem entweder Tasten A und/oder B am Produkt oder die Tasten an einer der Fernbedienung gedrückt werden. Die gedrückte Taste oder Tastenkombination zusammen mit der Dauer des Drückens (kurz, lang oder sehr lang) bestimmt, welcher Vorgang ausgewählt wird.









Hinweis... Die Tasten der Fernbedienung haben nur zwei Optionen: kurzes oder langes Drücken.

Um dem Anwender bei der Unterscheidung zwischen den drei verschiedenen Drücklängen zu unterstützen, gibt das Produkt für jede Drücklänge ein entsprechendes eindeutiges Muster an Signaltönen und Vibrationen ab und zeigt ein entsprechendes Symbol auf dem Bildschirm an, wie in der folgenden Tabelle dargestellt:

Name	Dauer	Zeitgesteuerte Signaltöne mit Vibrationen	Bildschirm-symbol	Im Dokument verwendetes Symbol
Kurzes Drücken	max. 2 Sekunden			
Langes Drücken	2–4 Sekunden			
Sehr langes Drücken	Länger als 4 Sekunden			



























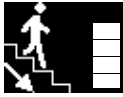







Produktanzeigen

Das Produkt bestätigt, dass der gewünschte Vorgang, z. B. der Wechsel des Modus, vom Produkt registriert wurde, indem es akustische Signale und/oder Vibrationen wie in der folgenden Tabelle dargestellt abgibt:

Art der Anzeige	Im Dokument verwendetes Symbol	
	Kurz	Lang
Akustisch (Signalton)	Hoher Ton 	
	Mittlerer Farbton 	
	Tiefer Ton 	
Vibration		
Auf dem Bildschirm	Siehe detaillierte Beschreibung in Abschnitt 10.3, 10.5 und 10.6.	
LED-Licht des ON/OFF-Schalters	Siehe detaillierte Beschreibung in Abschnitt 9.	

10.5 Moduswechsel am Produkt mit den Tectus-Modul-Tasten A und/oder B

Sobald der Startvorgang erfolgreich abgeschlossen ist, kann das Produkt mit Tastenkombinationen auf dem Tectus-Kniemodul oder der Fernbedienung gesteuert werden.

Modi	Initiierung (auf dem Produkt)	Timing-Hilfe		Produkt-Antwort		
		Auf dem Bildschirm	Signalton & Vibration	Signalton	Vibrations-signal	Angezeigtes Symbol
<i>Gehen</i>	Kurzer Tastendruck A 		1 	2x tiefer Ton kurz 	2x kurz 	
<i>Sitzen</i>	Langer Tastendruck B 		1+2 	1x mittelhoher Ton kurz 	1x kurz 	
<i>Stufen</i>	Kurzer Tastendruck B 		1 	2x mittelhoher Ton kurz 	2x kurz 	
<i>Frei</i>	Kurzer Tastendruck A&B 		1 	1x mittelhoher Ton lang 	1x lang 	
<i>Arretierung</i>	Langer Tastendruck A 		1+2 	2x mittelhoher Ton lang 	2x lang 	
<i>Lautlos</i>	Sehr langer Tastendruck A 		1+2+3 	2x mittelhoher Ton kurz 	2x kurz 	

Hinweis... Die Taste B sollte nicht länger als 4 Sekunden gedrückt werden, da sonst die **Bluetooth**®-Funktion versehentlich eingeschaltet werden könnte. Dies wird dadurch angezeigt, dass die Einschalttaste blau blinkt und durchgehend grün leuchtet und drei tiefe Töne und Vibrationen ausgibt. Hierbei handelt es sich nicht um eine Benutzerfunktion. Sie muss somit ausgeschaltet sein. Um Bluetooth® auszuschalten, schalten Sie das Produkt aus und mit dem ON/OFF-Schalter wieder ein (siehe Abschnitt 9), oder drücken Sie die Taste B länger als 4 Sekunden.



10.6 Einschalten des Produkts mit Hilfe der Fernbedienung

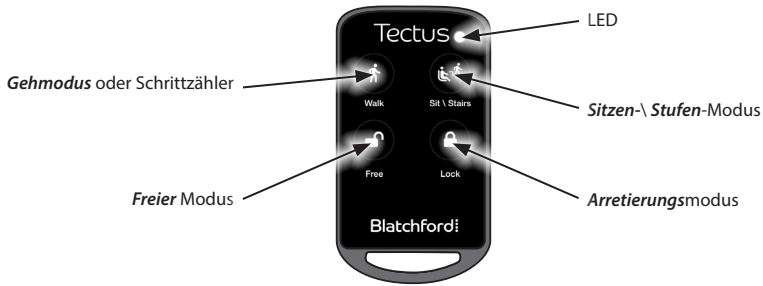

Modi	Initiierung (mit Fern- bedienung)	Timing-Hilfe		Produkt-Antwort		
		Auf dem Bild- schirm	Signalton & Vibration	Signalton	Vibrations- signal	Ange- zeigtes Symbol
Gehen	Kurzer Druck auf Geh-Taste		1	2x tiefer Ton kurz	2x kurz	
Sitzen	Kurzer Druck auf Sitzen/Stufen-Taste		1	1x mittelhoher Ton kurz	1x kurz	
Stufen	Langer Druck der Sitzen/Stufen-Taste		1+2	2x mittelhoher Ton kurz	2x kurz	
Frei	Kurzer Druck auf Frei-Taste		1	1x mittelhoher Ton lang	1x lang	
Arretie- rung	Kurzer Druck auf Arretierungs-Taste		1	2x mittelhoher Ton kurz	2x kurz	

10.7 Zusätzliche Funktionen der Fernbedienung

Modi	Initiierung (mit Fern- bedienung)	Timing-Hilfe		Produkt-Antwort		
		Auf dem Bild- schirm	Signalton & Vibration	Signalton	Vibrations- signal	Angezeig- tes Symbol
Schrittzähler	Langer Druck auf Geh-Taste		1+2	-	-	
Verbindungs- code	Langer Druck auf Arretierungs-Taste		1+2	-	-	

10.8 Mechanischer Override-Betrieb

Das Knie kann durch Drücken der Override-Taste oben auf dem Steuermodul in jedem Modus gebeugt werden. Die Taste muss so lange gedrückt und gehalten werden, bis der gewünschte Winkel der Knieflexion erreicht wurde.



Verwenden Sie keine Gegenstände (z. B. Schraubendreher, Stift), um die Override-Taste zu drücken.



Diese Funktion sollte nur in Ausnahmefällen verwendet werden (z. B. Störung des Produkts, leerer Akku).

Sobald Sie die manuelle Override-Taste loslassen, kehrt die Knieflexion zum gleichen Widerstand zurück, den sie vor dem Drücken der manuellen Override-Taste hatte.

Hinweis... Das Hydraulikmodul ist so konzipiert, dass die Extension der Beine immer frei ist.



Achten Sie bei der Flexion des Produkts immer auf das Risiko, sich die Finger einzuklemmen.

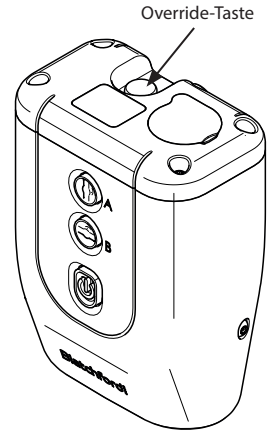

11 Transportieren und Lagern

1. Es wird empfohlen, das Produkt aufrecht zu lagern und es vor dem Ausschalten in den **Arretierungsmodus** zu versetzen.
2. Wenn die Tectus-KAFO aufrecht gelagert werden soll, sichern Sie das Produkt, damit es nicht umfallen kann.
3. Wenn das Produkt entweder allein oder in eine Tectus-KAFO eingebaut versandt wird, sollte es in ausgestreckter Position in den **Arretierungsmodus** versetzt und in einem geeigneten Karton verpackt werden.
4. Wenn ein Produkt zurückgeschickt werden soll, kontaktieren Sie Blatchford vor dem Versand, wenn der Akku offensichtliche physische Schäden aufweist.
5. Für den Transport muss das Produkt ausgeschaltet und sicher verpackt sein, damit
 - a) es nicht versehentlich eingeschaltet werden kann und während des Transports in Betrieb genommen wird,
 - b) die Tectus-KAFO/das Produkt sorgfältig vor Transportschäden geschützt ist.

FCC Compliance Statement



This device complies with part 15 of the FCC Rules.

Operation is subject to the following two conditions:

1. This device may not cause harmful interference.
2. This device must accept any interference received, including interference that may cause undesired operation.

Note... Contains pre-approved **Bluetooth**® module: FCC ID: QOO-GM220P IC: BGM220PC22HNA2.

This equipment has been tested and found to comply with the limits for a Class B digital device, pursuant to part 15 of the FCC Rules. These limits are designed to provide reasonable protection against harmful interference in a residential installation. This equipment generates uses and can radiate radio frequency energy and, if not installed and used in accordance with the instructions, may cause harmful interference to radio communications. However, there is no guarantee that interference will not occur in a particular installation. If this equipment does cause harmful interference to radio or television reception, which can be determined by turning the equipment off and on, the user is encouraged to try to correct the interference by one or more of the following measures:

- Reorient or relocate the receiving antenna.
- Increase the separation between the equipment and receiver.
- Connect the equipment into an outlet on a circuit different from that to which the receiver is connected.
- Consult the dealer or an experienced radio/ TV technician for help.

Any changes or modifications not expressly approved by the party responsible for compliance could void the user's authority to operate the equipment.

Caution: Exposure to Radio Frequency Radiation. This device must not be co-located or operating in conjunction with any other antenna or transmitter.

Responsible party: Blatchford Inc.

1031 Byers Road, Miamisburg, OH 45342
800-548-3534 (toll free) | 937-291-3636
customerservice@blatchfordus.com

RSS Compliance Statement

This device complies with RSS 210 of Industry Canada.

Operation is subject to the following two conditions:

1. this device may not cause interference, and
2. this device must accept any interference, including interference that may cause undesired operation of this device.

L' utilisation de ce dispositif est autorisée seulement aux conditions suivantes:

1. il ne doit pas produire d'interférence et
2. l' utilisateur du dispositif doit être prêt à accepter toute interférence radioélectrique reçue, même si celle-ci est susceptible de compromettre le fonctionnement du dispositif.

Caution: Exposure to Radio Frequency Radiation.

The installer of this radio equipment must ensure that the antenna is located or pointed such that it does not emit RF field in excess of Health Canada limits for the general population; consult Safety Code 6, obtainable from Health Canada's website Blatchford Inc. 1031 Byers Road, Miamisburg, OH 45342.

800-548-3534 (toll free) | 937-291-3636 customerservice@blatchfordus.com

Haftung

Der Hersteller empfiehlt, das Produkt nur unter den angegebenen Bedingungen und für die angegebenen Zwecke zu verwenden. Das Produkt muss entsprechend der mit dem Produkt gelieferten Gebrauchsanweisung gewartet werden. Der Hersteller haftet nicht für nachteilige Ergebnisse, die durch nicht autorisierte Komponentenkombinationen entstanden sind.

CE-Konformität

Das Produkt erfüllt die Anforderungen der europäischen Richtlinie EU 2017/745 für Medizinprodukte. Dieses Produkt wurde entsprechend den Klassifizierungskriterien in Anhang VIII der Richtlinie als Produkt der Klasse I klassifiziert. Die EU-Konformitätserklärung ist unter folgender Internetadresse abrufbar: www.blatchford.co.uk



Medizinprodukt



Ein Patient – Mehrfachverwendung

Garantie

Das Produkt verfügt über eine Garantie von 36 Monaten.

Eine routinemäßige Inspektion des Geräts ist nach 2 Wochen, 3 Monaten, 6 Monaten, 12 Monaten und 24 Monaten erforderlich.

Der Anwender muss sich bewusst sein, dass nicht ausdrücklich genehmigte Änderungen oder Modifikationen zum Verfall der Garantie, Betriebsgenehmigung und Ausnahmen führen können.

Die obigen Angaben können je nach Markt variieren. Für weitere Einzelheiten wenden Sie sich bitte an Ihren Vertreter vor Ort.

Auf der Blatchford-Website finden Sie die aktuellen, detaillierten Garantiebedingungen.

Bericht schwerer Zwischenfälle

Im unwahrscheinlichen Fall eines schweren Zwischenfalls in Verbindung mit diesem Produkt muss der Zwischenfall dem Hersteller und der für Ihr Land zuständigen Behörde gemeldet werden.

Umweltaspekte



Dieses Symbol zeigt an, dass das Produkt elektrische/elektronische Komponenten und/oder Batterien enthält, die am Ende der Produktlebensdauer nicht im Hausmüll entsorgt oder verbrannt werden dürfen.

Am Ende der Produktlebensdauer müssen alle elektrischen/elektronischen Komponenten und/oder Batterien gemäß den aktuellen Vorschriften für die Handhabung von WEEE (Elektro- und Elektronik-Altgeräte) oder den entsprechenden vor Ort geltenden Vorschriften recycelt oder entsorgt werden. Der Rest des Produkts sollte wenn möglich entsprechend den vor Ort geltenden Recyclingvorschriften recycelt werden.

Um potenzielle Umwelt- oder Gesundheitsschäden durch unkontrollierte Abfallentsorgung zu vermeiden, bietet Blatchford einen Rücknahmeservice an. Wenden Sie sich für weitere Details bitte an den Kundenservice.

Hinweise zu Handelsmarken

Tectus und Blatchford sind eingetragene Marken von Blatchford Products Limited.

Die Wortmarke Bluetooth® und die Logos sind eingetragene Handelsmarken der Bluetooth SIG Inc., und jegliche Nutzung dieser Marken durch Blatchford unterliegt einer Lizenzierung. Andere Handelsmarken und Markennamen sind Eigentum der jeweiligen Unternehmen.

Eingetragene Adresse des Herstellers



Blatchford Products Limited, Lister Road, Basingstoke RG22 4AH, Vereinigtes Königreich.

Innhold.....	62
1 Beskrivelse og tiltenkt formål	63
2 Sikkerhetsinformasjon.....	64
3 Konstruksjon.....	66
4 Hovedpunkter	68
5 Vedlikehold.....	68
5.1 Varsel om kritisk vedlikehold	69
5.2 Kald omstart.....	70
5.3 Rengjøring.....	70
5.4 Bytte batteri i fjernkontrollen	70
6 Bruksbegrensninger	71
7 Lading av batteri.....	72
7.1 Informasjon om sikkerhet ved lading av batteri.....	72
7.2 Før lading	73
7.3 Batterinivåindikator på skjermen	73
7.4 Koble til og koble fra laderen.....	74
7.5 LED-lys på batteriladeren	75
7.6 Referansetider for lading og bruk	75
8 Slik tas Tectus KAFO-en av og på.....	76
8.1 Slik tas Tectus KAFO-en på.....	76
8.2 Slik tas Tectus KAFO-en av	77
9 Slå enheten AV/PÅ.....	78
10 Bruk av Tectus-knemodulen.....	80
10.1 Brukermoduser	80
10.2 Sikkerhet ved bytte av modus	80
10.3 Aktiviteter og tilknyttede moduser	82
10.4 Handlinger og enhetsindikasjoner	86
10.5 Modusbytte på enheten med A- og B-knappene på Tectus-modulen.....	87
10.6 Modusbytte på enheten med fjernkontrollen.....	88
10.7 Flere fjernkontrollfunksjoner	88
10.8 Mekanisk overstyring.....	89
11 Transport og oppbevaring.....	89



Les alle sikkerhetsadvarsler i avsnitt 2 og 7 før du konfigurerer eller bruker enheten.

1 Beskrivelse og tiltenkt formål

Denne bruksanvisningen er ment kun for brukeren.

Ordet «enhet» i denne bruksanvisningen viser til Tectus, et knesystem bestående av Tectus-knemodulen, følgeleddet, batteripakken, sideskiner og tilhørende fjernkontroller. Ordene «Tectus KAFO» (kne-ankel-fot-ortose) eller «skinne» i denne bruksanvisningen viser til en brukertilpasset, total benortose som omfatter enheten og er laget i henhold til en leges foreskrivning.

Merk... Ankelledet er ikke laget av Blatchford og er ikke beskrevet i denne bruksanvisningen. Se produsentens dokumentasjon.

Ordet *programmeringsenhet* i denne bruksanvisningen viser til et nettbrett eller en mobiltelefon med Android- eller iOS-operativsystem.

Ordet *app* i denne bruksanvisningen viser til Tectus-programmeringsappen som er lagt inn på programmeringsenheten.

Forsikre deg om at du forstår alle bruksanvisningene, spesielt avsnittene om vedlikehold og sikkerhetsinformasjon.

Bruksområde

Denne enheten skal utelukkende brukes som en del av en protese for underekstremiteter.

Skal kun brukes av én person.

Denne enheten er et klasse I CE-merket medisinsk utstyr i henhold til forordningen om medisinsk utstyr 2017/745, og skal brukes som en del av en ortose for underekstremiteter. Skinnen er et spesialtilpasset medisinsk utstyr. Enheten, når den utgjør en del av en KAFO, er en mikroprosessorkontrollert sving- og stillingsenhet som sørger for automatisk justering av fleksjonsmotstand og manuell justering av ekstensjonsassistanse.

Med denne enheten kan du gjøre ting som å gå, stå, sette deg og gå ned trapper. Du kan kontrollere enheten ved å bytte mellom forskjellige moduser som passer til aktiviteten du skal gjøre, med kontrollknappene på enheten og/eller kontrollknappene på fjernkontrollen. Legen kan bruke disse kontrollene sammen med appen når hen skal tilpasse enheten til deg.

2 Sikkerhetsinformasjon



Dette advarselssymbolet fremhever viktig sikkerhetsinformasjon som må følges nøye.



Ta kontakt med legen hvis tilstanden din endrer seg.



Se jevnlige tegn på hudirritasjon, vevskade, trykksår eller ubehag på lemmet Tectus KAFO-en brukes på, og rapporter slike tegn til legen.



Montering, programmering, vedlikehold og reparasjon av enheten (inkludert håndtering og bytte av batterienhet) må bare utføres av en kvalifisert lege eller tekniker som har deltatt på et godkjent opplæringskurs.



Pass alltid på så fingrene ikke kommer i klem.



Ikke plasser den nær en varmekilde. Ikke forlat den i direkte sollys eller inni en bil når det er varmt vær.



Unngå sterke magnetfelt, radioaktivitet, kilder til elektrisk interferens, miljøer som inneholder væsker og/eller pulver.



Enheden skal ikke brukes når det tas skanninger (f.eks. røntgen, CT eller MR).



Enheden er ikke egnet til bruk i vann eller som dusjortose. Hvis ortosen kommer i kontakt med vann, må den tas av og tørkes umiddelbart.



Store endringer i hæløyde etter at enheten er programmert, vil ha negativ innvirkning på funksjonen til ortosen. Alt fottøy som skal brukes med ortosen, må godkjennes av lege.



Si fra til legen hvis du har pacemaker eller annet elektronisk medisinsk utstyr før du bruker denne enheten.



Pass på at det ikke kommer vann inn i ladekontakten, og at dekslet kun tas av ved lading.



Mer sikkerhetsinformasjon finnes i avsnitt 7.1 *Informasjon om sikkerhet ved lading av batteri*.

Husk på følgende advarsler når du bruker enheten:



Eventuelle endringer i ytelsen eller funksjonen til enheten, f.eks. begrenset bevegelse, ujevn bevegelse eller uvanlige lyder, skal umiddelbart rapporteres til legen eller tjenesteleverandøren.



Forsikre deg om at bare kjøretøyer med passende ettermontering brukes når du kjører. Alle personer må overholde gjeldende vegtrafikklover når de bruker motorvogner. Benet som ortosen sitter på, må ikke brukes til å styre kjøretøyet (f.eks. clutch-pedal, bremsepedal, gasspedal).





















Du må ikke kjøre store maskiner mens du har på deg enheten.



Hold alltid i et rekkverk når du går opp og ned trapper og når som helst ellers hvis det er tilgjengelig.



Når du går ned trapper, skal du kun forsøke å sette et ben foran det andre hvis du har fått opplæring i det og legen har sagt du kan gjøre det. Ellers må brukeren gå med en «sett foten inntil»-bevegelse når hen går ned trapper.

-  Når du begynner å gå, skal du alltid begynne med det friske benet. Hvis brukeren begynner å gå med ortosen først, kan det hende enheten ikke gjenkjenner bevegelsen, og den bytter da til *låsmodus* som et sikkerhetstiltak.
 -  Brukeren må sjekke at *trappemodus* er aktivert før hen forsøker å gå ned trapper.
 -  Brukeren må sjekke at *sittemodus* er aktivert før hen forsøker å sette seg ned.
 -  Enheten skal ikke brukes til uvanlige aktiviteter, deriblant ekstrem sport (friklatring, fallskjermhopping, paragliding osv.), sport som omfatter hopping, plutselige bevegelser eller raske skrittsekvenser (f.eks. løping, sykkeløp, basketball, badminton, vintersport) eller ekstreme bakker og trinn.
 -  Unngå om mulig å gå med enheten på glatte eller myke underlag (sand, snø, gjørme osv.). Brukeren må være svært forsiktig om det ikke er mulig å unngå disse.
 -  Hvis varselet om kritisk vedlikehold aktiveres og ikke kan tilbakestilles (se avsnitt 5.1 *Varsel om kritisk vedlikehold*), må du slutte å bruke enheten så snart som praktisk mulig og ta kontakt med legen for å avtale vedlikehold.
 -  Du må ikke tukle med eller endre noe på enheten.
 -  Brukeren må ikke endre eller bytte ut stroppene eller polstringen på KAFO-en som er foreskrevet av legen.
 -  Knemodulen kan etter kontinuerlig bruk bli varm ved berøring.
 -  For å redusere risikoen for å gli og snuble må egnet fottøy som passer godt på fotdelen, brukes til enhver tid.
 -  Hvis du bærer last, kan dette påvirke holdningen din og evnen til å overholde de nødvendige parameterne for at kneet skal frigis fra stillingen.
 -  Ha fjernkontrollen på en egen stropp og unna andre nøkler, slik at den ikke bytter modus ved et uhell.
 -  Pass på at klær ikke setter seg fast i de bevegelige delene til enheten.
 -  Brukeren må passe på at stroppen til fjernkontrollen ikke utgjør noen kvelningsfare, f.eks. hvis den setter seg fast i roterende maskineri.
 -  Når fjernkontrollsnoren ikke er i bruk, må den oppbevares på et trygt sted for å unngå kvelningsfare for barn.
 -  Enheten er ikke laget for å kunne gå baklengs. Brukeren må ikke forsøke å gå bakover, da det ikke er sikkert enheten kan støtte hen.
- I *gåmodus*, når enheten registrerer bevegelse bakover, låser den seg i ekstensjon for å gi ståstøtte. Se avsnitt 10.3 *Aktiviteter og tilknyttede moduser* for mer informasjon.
-  Bruk av andre tilbehør, transdusere og ledninger enn dem som er spesifisert eller levert av produsenten av utstyret, kan føre til at utstyret får økt elektromagnetisk utslipp eller redusert elektromagnetisk immunitet, som igjen kan føre til at det ikke fungerer som det skal.
 -  **ADVARSEL:** Bærbart RF-kommunikasjonsutstyr (radiofrekvens) (inkludert eksterne enheter som antennekabler og eksterne antenner) skal ikke brukes nærmere enn 30 cm fra noen del av enheten, inkludert ledninger spesifisert av produsenten, da det kan føre til at enheten ikke fungerer som den skal.

3 Konstruksjon

Viktigste deler

- Tectus-knemodul Titan, rustfritt stål, aluminium, elastomer, termoplast, elektroniske deler, hydraulikkvæske
- Batterimodul NiMH-batteri, termoplast
- Følgeledd Rustfritt stål, aluminium, elastomer, termoplast
- Sideskinner for kne Titan
- Batterilader Termoplast, elektroniske deler
- Fjernkontroller Termoplast, elektroniske deler, litiumbatteri
- Lår, leggdeksel, stropper, ankelmodul og fotdeler Se produsentens dokumentasjon

Komponentidentifisering

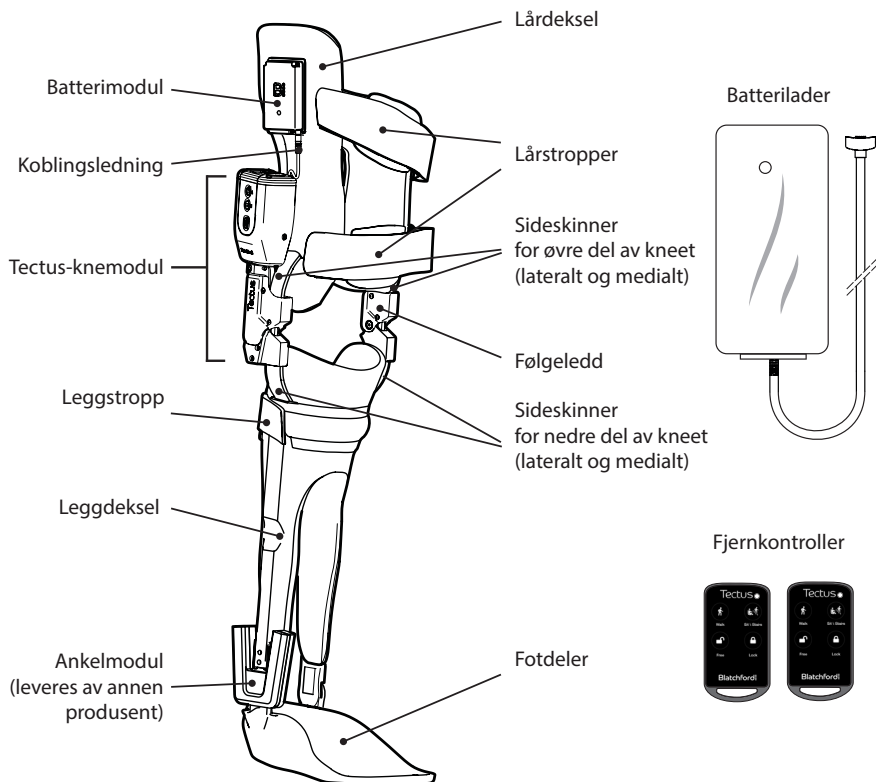

Merk... I illustrasjonene vises kun Tectus KAFO-en for høyre ben.

**Tectus-knemodul
(høyre ben vises her)**

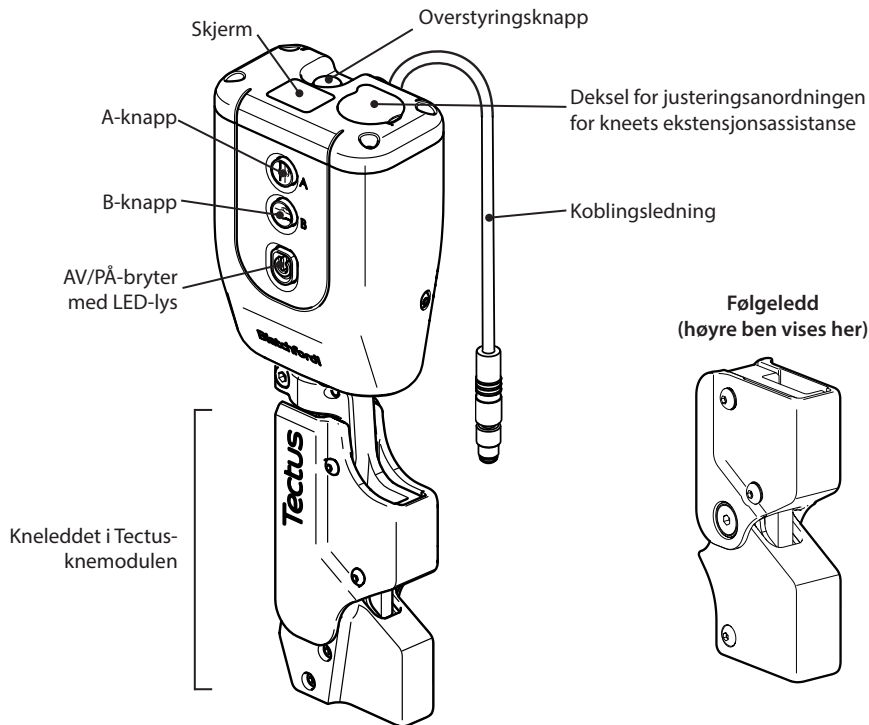

Batterimodul

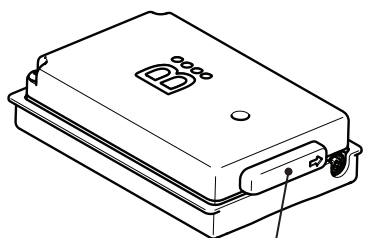

Ladekontakt for batteri
(under dekselet)

Sideskiner for kne

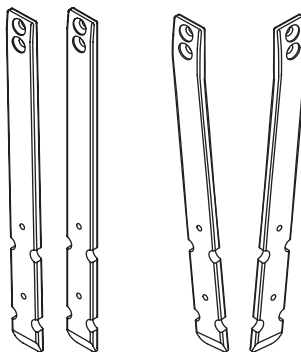

938467

4 Hovedpunkter

Den mikroprosessorkontrollerte enheten tilpasses deg av legen, og tilpasser seg bevegelsene dine i sanntid.

Med AV/PÅ-knappen og de to trykknappene (A og B) kan du kontrollere enheten lokalt med forskjellige knappkombinasjoner. Se avsnitt 10.5 *Modusbytte på enheten med A- og B-knappene på Tectus-modulen*.

Du kan ikke endre programmeringen til enheten selv. Legen må gjøre dette. Du kan imidlertid bytte manuelt mellom forskjellige moduser med fjernkontrollen og/eller A- og B-knappene og slik tilpasse enheten til bestemte forhold. Når du skal gå ned trapper, kan du for eksempel velge **trappemodus** rett før du begynner å gå nedover. I **trappemodus** gir enheten brukeren støtten hen trenger ved å øke fleksjonsmotstanden. Bruk av enheten og tilgjengelige moduser beskrives i avsnitt 10 *Bruk av Tectus-knemodulen*.

Med fjernkontrollen med snor og fire knapper kan du bytte modus for enheten. Se avsnitt 10.6 *Modusbytte på enheten med fjernkontrollen*.

Hvis elektronikken eller det hydrauliske kontrollsystemet svikter, eller når batteriet er helt utladet, bytter enheten automatisk til **sikkerhetsmodus**. I **sikkerhetsmodus** går enheten tilbake til motstandsparameterne den hadde før programmeringen og har begrenset funksjonalitet. Normal drift gjenopptas når enheten slås på etter at feilen er rettet eller batteriet er ladet opp. Se avsnitt 5.1 *Varsel om kritisk vedlikehold* og avsnitt 7.3.2 *Atferd ved lavt batterinivå*.

Enheden har en mekanisk overstyringsknapp som, når den trykkes inn, lar kneet flekere.

Se avsnitt 10.8 *Mekanisk overstyring*

5 Vedlikehold

Tectus KAFO-en må vedlikeholdes i henhold til følgende intervaller etter at den er blitt tilpasset brukeren:

2 uker	3 måneder	6 måneder	12 måneder	24 måneder
--------	-----------	-----------	------------	------------

Vedlikehold må gjøres av opplært personell i henhold til vedlikeholdsplanen fra Blatchford ACS.



Vedlikehold må gjøres i henhold til vedlikeholdsplanen, og Blatchford må informeres om resultatet for at garantien skal forbli gyldig.

Ikke gjør vedlikehold på enheten selv. Be heller legen eller tjenesteleverandøren gjør det. Hvis enhetens garanti fortsatt er gyldig, låner vi deg en ny kneenhet mens vi gjør vedlikehold. Både låneenheden og enheten som er vedlikeholdt, må konfigureres av legen før du kan bruke den.

Eventuelle endringer i ytelsen til denne enheten må rapporteres til legen.

Endringer i ytelse kan omfatte:

- økt eller redusert stivhet i kneet
- Ustabilitet
- nedsatt knestøtte (fri bevegelse)

- ukjente pip, varselys, indikasjoner på skjermen eller vibrasjoner*
- Eventuelle uvanlige lyder

*Enheten vibrerer når den bytter modus. Dette er normalt.



Ikke smør enheten selv. Dette gjøres under vedlikehold med egnet smøremiddel.

Ikke bruk WD40 eller noe annet vanddispersjonsmiddel på noen av de bevegelige delene som et forsøk på å fikse unormale lyder eller knirkende eller stive ledd.

Sjekk enheten før hver bruk for fysisk skade og

- tegn på slitasje
- hydraulisk lekkasje
- godt festede leddeksler
- godt festede stropper

Bytt batteri på fjernkontrollen hver sjetten måned,

- når modusbytte ikke fungerer som det skal
- hvis LED-lyset på fjernkontrollen ikke lyser hver gang brukeren trykker på knappene

Se avsnitt 5.4 **Bytte batteri i fjernkontrollen**, eller be lege/tjenesteleverandør om å gjøre det hvis du ikke er i stand til å gjøre det selv.

5.1 Varsel om kritisk vedlikehold

Hvis enheten oppdager en feil, aktiveres ikonet for kritisk vedlikehold og blinker på enhetens skjerm (se bilde). Enheten forsøker å gå i **sikkerhetsmodus** med høyere enn normal fleksjons- og ekstensjonsmotstand i kneet. Samtidig begynner B-knappen å blinke rødt til feilen er løst.

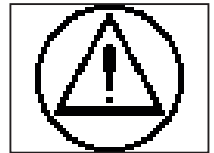

I **sikkerhetsmodusen** kan du sakte strekke ut og bøye kneet slik at du kan komme deg i sikker stilling og ta av enheten.



Hvis sikkerhetsmodusen ikke aktiveres, må du slutte å bruke enheten umiddelbart.

Hvis knevinkelen må justeres, kan brukeren bruke overstyringsknappen til å la enheten bøyes og strekkes ut fritt. Se avsnitt 10.8.



ADVARSEL! Bruk overstyringsknappen kun hvis det er trygt.



Hvis det oppstår feil på enheten og feilen ikke kan løses med en kald omstart (se avsnitt 5.2), eller hvis varselet om kritisk vedlikehold vises, må du ta kontakt med legen så snart som mulig, og du må ikke bruke enheten før feilen er blitt rettet og/eller vedlikehold er blitt gjort.

Varselet om kritisk vedlikehold blinker kontinuerlig og kneet forblir i denne modusen frem til feilen er løst. Hvis enheten slås av mens varselet for kritisk vedlikehold er aktivt, slås den av, men neste gang enheten slås på, begynner det å blinke igjen og fortsetter frem til feilen er løst.

5.2 Kald omstart

Ved små eller enkeltstående feil kan hard omstart forsøkes for å la enheten gjenopprette seg selv. Slik utføres kald omstart: Slå enheten AV og PÅ med AV/PÅ-knappen på knemodulen.



Ta kontakt med legen hvis feilen vedvarer.

5.3 Rengjøring

Blatchford anbefaler at enheten rengjøres daglig. Rengjør utvendige overflater med en fuktig klut og mild såpe. IKKE bruk sterke rengjøringsmidler eller blekemidler. Skal ikke i vaskemaskin eller tørketrommel, og det må ikke brukes vannslange, høytrykksspyler eller trykklufttørker.

Pass på at det ikke kommer vann inn i ladekontakten. Tørk nøye før bruk.

5.4 Bytte batteri i fjernkontrollen

Fjernkontrollen har et rundt CR 2032-batteri. Batteriet må byttes hver sjette måned, når modusbytte ikke fungerer som det skal, eller hvis LED-lyset på fjernkontrollen ikke lyser hver gang brukeren trykker på knappene.



1
Legg fjernkontrollen på flatt underlag med batteridekselet opp.



2
Skrut ut begge skruene med en stjerneskrutrekker og legg dem til sides.



3
Bruk en skrutrekker med flatt hode til å løfte dekselet fra enden nærmest nøkkelringen som vist for å unngå skade på pakningen.



4
Ta ut det tomme batteriet, og kast det i henhold til lokale forskrifter om gjenvinning.



Batterier må holdes unna barn og kjæledyr. Søk legehjelp hvis batteriet svelges.



Når batteriet er byttet, må du teste at alle knappene på fjernkontrollen bytter modus som de skal, og at LED-lyset lyser hver gang en knapp trykkes inn.

6 Bruksbegrensninger

Løftebelastninger

Brukerens vekt og aktivitetsnivå bestemmes av de angitte grensene.

Lastbæring av brukeren skal være basert på en lokal risikovurdering. Undersøkelsen må ta hensyn til at bæring av last kan påvirke brukeren holdning og evne til å overholde de nødvendige parameterne for at kneet skal frigis fra stillingen.

I alle tilfeller må ikke den kombinerte vekten av brukeren og lasten overstige 100 kg.

Miljø

Unngå å eksponere Tectus KAFO-en for korrosive elementer slik som vann, syrer og andre væsker. Unngå også slipingende miljøer som for eksempel inneholder sand, fordi dette kan føre til for tidlig slitasje.

Merk... Det er kun knemodulen og batteripakken som er spruttette i henhold til IP54-standard.















Skal bare brukes ved temperaturer mellom -10°C og 50°C .



Egnet for utendørs bruk

7 Lading av batteri

7.1 Informasjon om sikkerhet ved lading av batteri

-  Laderen skal aldri kobles til enheten mens enheten er i bruk.
-  Batteriet skal kun lades ved temperaturer mellom 0 °C og 35 °C.
-  Batteriladeren kan brukes i stikkontakter med spenning mellom 100 V og 240 V vekselstrøm, 50/60 Hz.
-  Enhetens batteri skal kun lades med laderen og ladekabelen som følger med. Laderen skal ikke brukes til å lade annet utstyr.
-  Laderen må ha riktig støpsel for landet. Støpselet må aldri presses inn i en stikkontakt som ikke er kompatibel.
-  Før lading må brukeren sjekke at ladeflatene er tørre og rene. Skitt og smuss kan forstyrre ladingen.
-  Hvis brukeren merker uvanlige lyder eller lukter mens enheten lades, må laderen trekkes ut og både laderen og knemodulen må slås av. Rapporter problemet til legen.
-  Koblingen mellom batterimodulen og batteriladeren inneholder sterke magneter. Det må alltid holdes trygg avstand (minst 10 cm) mellom disse magnetene og gjenstander som kan bli påvirket av magnetisme, f.eks. klokker, pacemakere, bankkort og magnetisk lagrede medier.
-  Ikke la noe materiale av jern feste seg på ladeflatene.
-  Ikke ta støpselet eller batteriladeren fra hverandre.
-  Skadede støpsler eller batteriladere må umiddelbart byttes ut med deler fra Blatchford.
-  Enheten slår seg av mens den lades. Når enheten er ferdig ladet, må den slås på med AV/PÅ-knappen på Tectus-knemodulen.
-  Ikke ta ut batteriene. De kan ikke byttes ut av brukeren, og byttes ved behov under rutinemessig vedlikehold.
-  Hvis enheten er blitt utsatt for temperaturer under -10 °C, må den returneres til Blatchford slik at vi kan sjekke om batteripakken har tatt skade.

7.2 Før lading



Enheten skal ikke lades mens brukeren har den på. Tectus KAFO-en må tas av før den lades. Brukeren må ikke ta på enheten mens den fortsatt er koblet til laderen.

Brukeren må alltid sjekke at enheten har nok batteri til å vare gjennom hele dagen. Vi anbefaler at enheten lades hver dag hvis den brukes hver dag.

Før lading anbefaler vi å bytte til *låsemodus* og legge Tectus KAFO-en vannrett (på en flate eller på gulvet) med knemodulen opp og med fem graders fleksjon i kneet slik at den ligger trygt og ikke ruller til siden.

Merk... Knemodulen slår seg av automatisk så snart laderen kobles til.

7.3 Batterinivåindikator på skjermen

7.3.1 Vanlige indikasjoner

Batterinivåindikatoren vises i 5 sekunder på siden av skjermen på enheten:

- når modusen byttes
- når A- og B-knappen holdes inne samtidig

Enheten har følgende batterinivåindikasjoner:

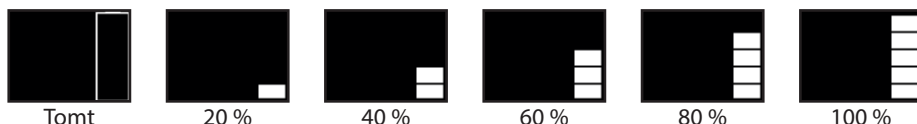

7.3.2 Atferd ved lavt batterinivå

Varsel om lavt batterinivå

Enheten varsler deg når batterinivået faller til 20 % ved å avgi to korte pip og vise varselsymbolet fulgt av én strek på skjermen. Dette varselet gjentas hvert tiende minutt og/eller hver gang brukeren trykker på en knapp, frem til batterinivået blir kritisk lavt.



Varsel om kritisk lavt batterinivå

Et kritisk lavt batterinivå indikeres med et blinkende varselsymbol og ett langt pip. Enheten går tilbake til en *sikkerhetsmodus* som er identisk den som er beskrevet i avsnitt 5.1 *Varsel om kritisk vedlikehold*.



Når varselet om kritisk lavt batterinivå vises, må du slutte å bruke enheten og ikke bruke den igjen før den er oppladet.

7.3.3 Tom skjerm etter at batteriladeren er koblet til

Hvis skjermen forblir tom etter at batteriladeren er koblet til og skrudd på, kan det hende batteriet er helt utladet. La batteriladeren være koblet til i minst 15 minutter, og sjekk ladenivået ved å koble fra laderen og koble den til igjen

7.4 Koble til og koble fra laderen

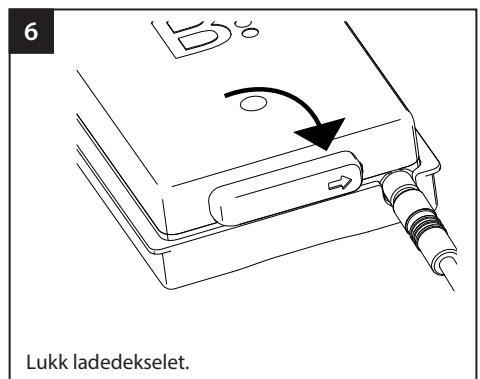
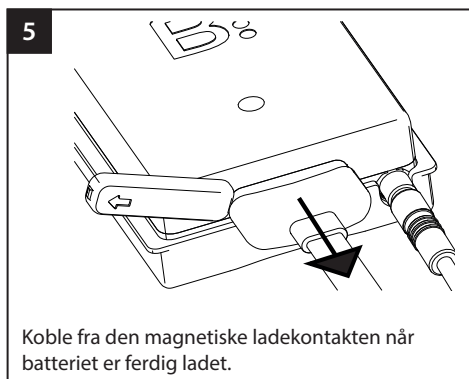
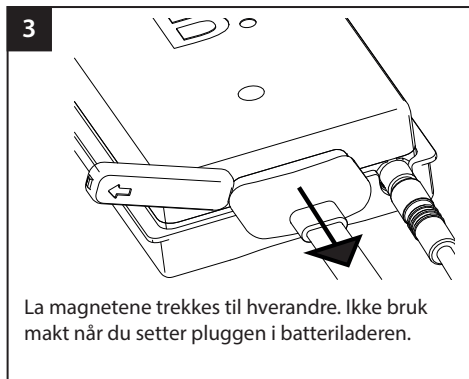
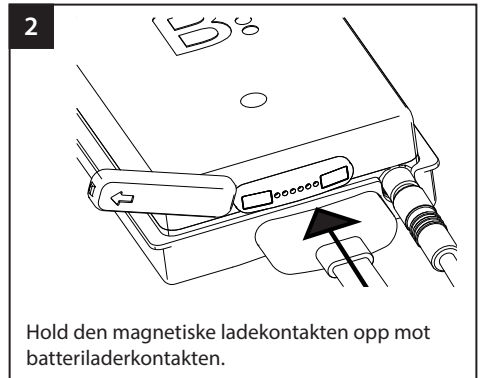
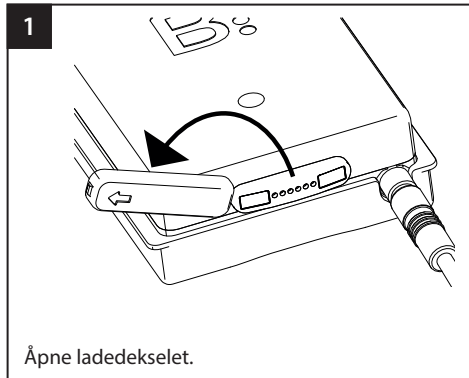

7.5 LED-lys på batteriladeren

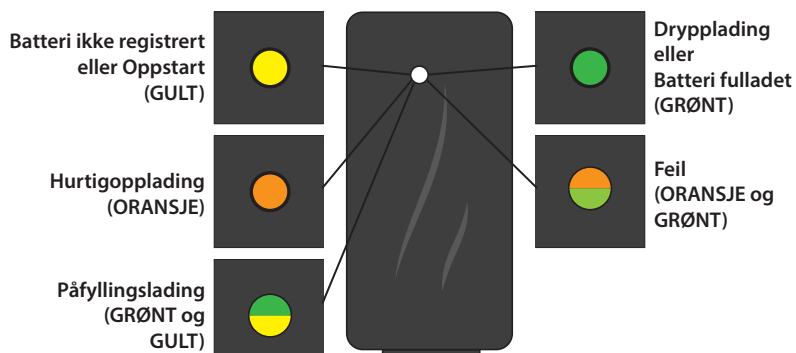

Merk... Du finner mer informasjon på baksiden av batteriladermodulen og i instruksene som følger med laderen.



Oppstartssekvens

Når laderen er satt i stikkontakten og koblet til enheten, må den slås på ved stikkontakten. Laderens LED-lys lyser i følgende fargesekvens i ca. 10 sekunder for å vise at enheten lades.

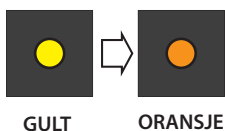

7.6 Referansetider for lading og bruk

Prosess	Tid
Tid til helt oppladet batteri (fra helt tomt).	Ca. 2 timer
Minste ladetid før bruk (fra helt tomt).	Minst 1 time
Maksimal batterivarighet fra helt oppladet og ved kontinuerlig bruk, f.eks. uavbrutt gåing. (Avhenger av temperatur)	18 timer (se merknad i og ii)

- Merknader:
- i) For at batteriet skal vare lengst mulig på én lading, anbefaler vi å slå av enheten når den ikke er i bruk.
 - ii) Brukstiden til enheten kan reduseres hvis omgivelsestemperaturen er lav eller batteriet er gammelt.

8 Slik tas Tectus KAFO-en av og på

8.1 Slik tas Tectus KAFO-en på

Merknader: i) Lad enheten før du tar den på. (Se avsnitt 7 *Lading av batteri*.)

ii) Sjekk enheten daglig for feil og mangler som kan påvirke enhetens sikkerhet og funksjon. Hvis du ser noe unormalt, må du ta kontakt med legen.

1. Åpne alle lukkestropper slik at de ikke kommer i veien for dekselåpningene.
 2. Ta av skoen.
 3. Sitt på kanten av en stol.
 4. Slå enheten PÅ. (Se avsnitt 9.)
 5. Hvis enheten slås PÅ mens den ligger horisontalt, skal den starte opp i **frimodus**. Hvis den ikke gjør det, bytter du til **frimodus** med fjernkontrollen eller knappene.
 6. Bøy Tectus KAFO-en ved kneet.
 7. Strekk ut benet litt, og før låret inn i lårdekslet.
 8. Sett foten i fotdelen, posisjoner hælen og sett leggen i leggdekslet.
 9. Fest alle stroppene. Ikke stram for hardt.
 10. Sjekk at ortosen sitter behagelig. (Endre etter behov, f.eks. passende trimmelinjer.)
 11. Ta skoen på fotdelen. (Enkelte brukere foretrekker å ta på seg Tectus KAFO-en med skoen på).
 12. Still enheten til **gåmodus** og reis deg (hold deg i noe støttende ved behov). Juster alle fester og stropper etter behov.
 13. Hvis enheten brukes over klær, pass på at stoffet er pent brettet slik at det ikke skaper ubehag.
Hvis enheten brukes under klær (f.eks. kjole, skjørt, løstsittende bukser), bør det brukes en sokk eller et tynt plagg som dekker hele lengden av benet.
-  **Pass på at klær ikke setter seg fast i de bevegelige delene til enheten.**
14. Still enheten til **sittmodus** og sett deg forsiktig.
 15. Still enheten til **frimodus** og bøy og strekk ut kneet forsiktig for å sjekke at Tectus KAFO-en sitter behagelig i hele bevegelsen.
 16. Still enheten til **gåmodus** igjen før du reiser deg.

8.2 Slik tas Tectus KAFO-en av

1. Still enheten til *sittmodus*.
2. Sett deg på kanten av en stol (støtt deg på stolen om nødvendig).
3. Still enheten til *frimodus*.
4. Ta av skoen.
5. Åpne alle stroppene.
6. Ta av Tectus KAFO-en.
7. Strekk ut KAFO-en til 5 graders knefleksjon og still enheten til *låsemodus*.
8. Slå enheten AV.
9. Legg Tectus KAFO-en vannrett (på en flate eller på gulvet) med knemodulen opp og med fem graders fleksjon i kneet slik at den ligger trygt og ikke ruller til siden.

Merk... Vi anbefaler å sette enheten til lading etter hver bruk.



Se jevnlig etter tegn på hudirritasjon, vevskade, trykksår eller ubehag på lemmet Tectus KAFO-en brukes på, og rapporter slike tegn til legen

9 Slå enheten AV/PÅ

Enheden slås av og på med AV/PÅ-knappen på enheden. Det er ikke noen AV/PÅ-knapp på fjernkontrollen.

Slå PÅ

Trykk på og hold inne AV/PÅ-knappen til LED-lyset lyser grønt. Enheten piper kort og vibrerer i oppstartssekvensen. Når den er ferdig, kan du slippe.

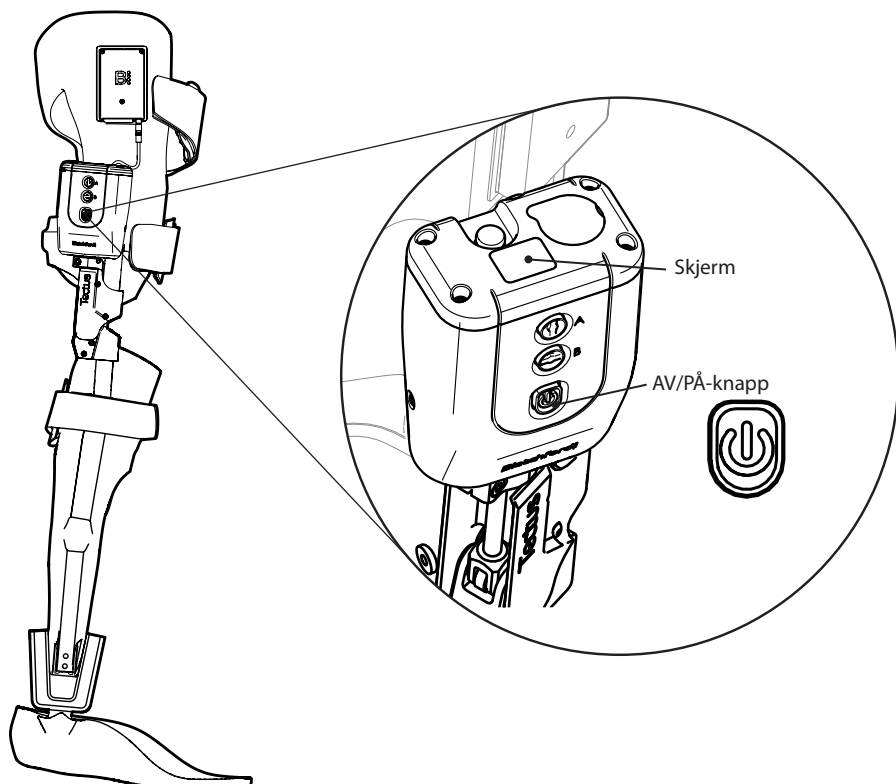

Slå AV

Trykk på og hold inne AV/PÅ-knappen til enheten piper kort og vibrerer to ganger. Deretter kan du slippe.



Oppstartssekvens

Når enheten slås PÅ, starter den automatiske oppstartssekvensen. Mens den pågår, endres LED-lysene og skjermen, og enheten avgir pip og vibrasjoner som vist. Sekvensen varer i omtrent 4 sekunder.

 **Ikke bruk enheten hvis det BLÅ LED-lyset fortsetter å blinke under og etter oppstartssekvensen. Dette indikerer at programmeringen til enheten ikke er fullført. Ta kontakt med legen før du bruker enheten.**

Enheden er PÅ og klar til bruk når standard *fri-/gåmodus* (avhengig av om enheten ligger eller står mens den starter opp) vises på skjermen (se sekvensen til høyre).

Merk... Skjermen går i dvalemodus (skjermen er tom) etter 5 sekunder uten aktivitet, men aktiveres hver gang modusen endres med A- eller B-knappene på enheten eller med fjernkontrollen.

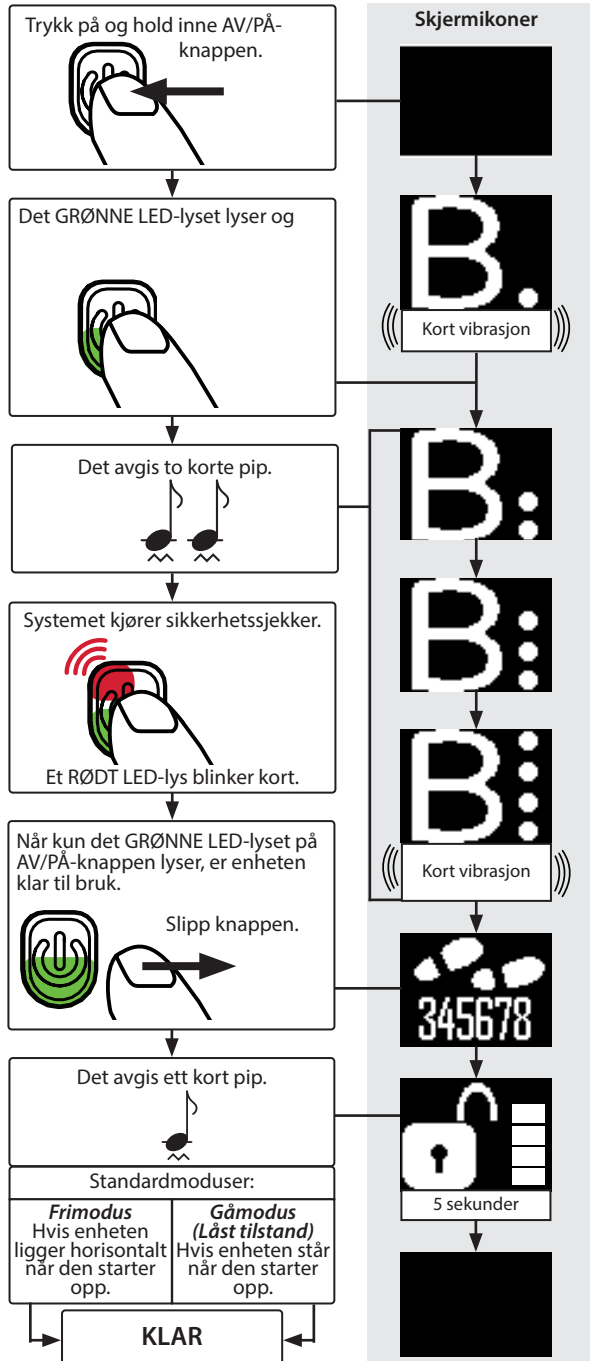

10 Bruk av Tectus-knemodulen

10.1 Brukermoduser

Enheten har disse modusene som brukeren kan velge mellom:

- *Gå*
- *Sitt*
- *Trapper*
- *Lås*
- *Fri*
- *Stille*

Enheten kan bytte automatisk til disse modusene:

- *Kritisk vedlikehold*
- *Sikker*

Enheten har denne modusen som kun legen kan velge:

- *Opplæring*

10.2 Sikkerhet ved bytte av modus

10.2.1 Standard brukermodus

Etter oppstart bytter enheten som standard til *frimodus* hvis brukeren sitter, eller *låsetilstanden i gåmodus* hvis brukeren står. *Frimodus* under oppstart er kun tiltenkt å brukes mens brukeren tar på seg enheten. Brukeren må velge en annen modus (som regel *gåmodus*) før hen reiser seg etter å ha tatt på seg enheten.

10.2.2 Sikkerhetsbegrensninger for bytte av modus

Brukeren kan ikke bytte til *frimodus* mens hen går, går ned trapper eller står med låst kne. Dette er av sikkerhetsmessige årsaker, fordi brukeren kan falle hvis støtten plutselig forsvinner. Derfor er følgende modusbytter ikke mulige:

Gåmodus til frimodus

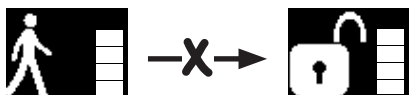

Trappemodus til sittemodus



Trappemodus til frimodus

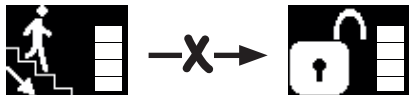

Sittemodus til trappemodus



Låsemodus til frimodus

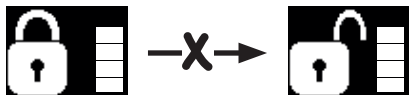

Frimodus til trappemodus



10.2.3 Varsel om overbelastning på enheten

Svært sjeldent og under spesielle forhold kan enheten avgi en rask, pipende lyd- og vibrasjonsalarm i opptil 15 sekunder. Dette betyr at enheten er overbelastet, enten fordi den ikke brukes som tiltenkt eller på grunn av en feil.

Når varsler om overbelastning oppstår

Hvis du (eller enheten selv) løser årsaken til overbelastningen før alarmen på 15 sekunder er over, stopper alarmen og enheten fungerer som normalt igjen.



Hvis du (eller enheten selv) ikke løser årsaken til overbelastningen før alarmen på 15 sekunder er over, tolker enheten dette som en feil og bytter automatisk til **sikkerhetsmodusen**.











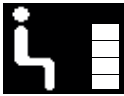

Hvordan overbelastning oppstår og hvordan unngå det

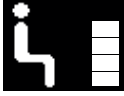
I denne tabellen oppsummeres scenarioene der enheten kan bli overbelastet, og hva som kan gjøres for å fikse det.

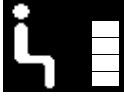





Alarm	Årsak	Løsning
Når modusen byttes	Det kan hende du har forsøkt å bytte modus før den forrige aktiviteten var helt ferdig, og det hydrauliske systemet var ikke klart til å tilpasse seg de nye innstillingene.	Prøv å redusere belastningen på enheten til den kan utføre modusbyttet. De raske pipene skal da stoppe umiddelbart for å indikere at enheten fungerer normalt igjen. Gi alltid enheten nok tid til å respondere på kommandoer om modusbytte.
Når brukeren setter seg ned	Når brukeren setter seg, bytter enheten automatisk til en lavere motstand etter at kneet har beveget seg ca 45°. Hvis du prøver å sette deg ned for raskt og hardt, overbelastes det hydrauliske systemet når det bytter modus.	Prøv å redusere belastningen på enheten til den kan bytte til frimodus . Følg legens anvisninger om hvordan og hvor raskt du skal sette deg når du bruker enheten.
Ved feil	Hvis problemet ikke løses innen 15 sekunder, antar enheten at det har oppstått en feil og går tilbake til sikkerhetsmodus , og varselet om kritisk vedlikehold vises på skjermen på enheten.	Se avsnitt 5.1 Varsel om kritisk vedlikehold om hvordan du løser feil. Her finner du også en beskrivelse av sikkerhetsmodusen .

10.3 Aktiviteter og tilknyttede moduser

Aktivitet	Modus aktivert og vist	Funksjon og prosedyre
<p>Gå</p> 	<p>Gå</p> 	<p>Gir automatisk støtte i stillingsfasen og kontrollerer frigivelsen i svingfasen. Kneekstensjonsassistansen er alltid på, selv om den ikke kontrolleres av mikroprosessor.</p>
<p>Stå</p> 	<p>Gå</p>  <p>Lås</p> 	<p>Hvis du står i ro mens enheten er i gåmodus, støttes du opp. I stående stilling varsles enheten om bevegelser som skritt fremover eller bakover, og gir støtte deretter.</p> <p>Vi anbefaler at du bruker låsmodusen for å få nok støtte når du skal stå over lengre tid (f.eks. når du står i kø) eller i miljøer der du kan komme ut av balanse (f.eks. hvis du står i en folkemengde).</p> <p>Merk... Låsmodus er en fiksert modus, og enheten overvåker ikke bevegelser. Låsmodus på slås av og på manuelt.</p>
<p>Skritt bakover</p> 	<p>Gå</p> 	<p>Hvis du trår bakover eller lener deg bakover i gåmodus, går enheten inn i en låst tilstand som kalles Skritt bakover. Den gir deg støtte mens du får igjen balansen.</p> <p>Merk... Skritt bakover er en tilstand i gåmodusen, og er ikke det samme som låsemodusen som brukeren selv kan velge.</p> <p>Hvis opplæringsmodusen er aktivert, indikerer enheten at den er i Skritt bakover-tilstanden ved å avgi én lang, høy pipetone og én vibrasjon.</p> <p>Enheden går tilbake til stående låsmodus først når du har gått tilbake til og forblitt i stående posisjon i minst to sekunder. Hvis opplæringsmodusen er aktivert, indikerer enheten dette ved å avgi to pip og vibrasjoner.</p>
<p>Lås</p>	<p>Lås</p> 	<p>Kneet er låst mot fleksjon, men kan strekke seg ut til full ekstensjon.</p> <p>Låsmodusen forblir på til en annen modus velges, eller til den mekaniske overstyringsknappen trykkes.</p>
<p>Fri</p>	<p>Fri</p> 	<p>Enheden gir minimal motstand i fleksjon og minimal ekstensjonsassistansmotstand i ekstensjon.</p> <p>Frimodus forblir på til en annen modus velges.</p> <p> Denne modusen gir ikke nok støtte til at brukeren kan stå.</p>

Aktivitet	Modus aktivert og vist	Funksjon og prosedyre
Stående til sittende 		<p>Fiksert motstand i kneet for å gi støtte idet brukeren setter seg. Geometrien i modulen sikrer best mulig støtte.</p> <p>Når du skal sette deg, må du manuelt aktivere sittmodusen med modusknappene på enheten eller på fjernkontrollen.</p> <p>Vær oppmerksom på omgivelsene rundt deg før du setter deg. Belast begge bena likt når du setter deg. Bøy deg fremover ved hoften, skyv rumpa bakover, legg hendene på armlenet (hvis det finnes) og bøy bena i en jevn bevegelse til du sitter.</p>
Sette seg 	 	<p>I sittmodus, to sekunder etter at brukeren har satt seg, bytter enheten automatisk til frimodus for å gjøre det mulig for brukeren å flytte på lemmet ved behov.</p> <p>Merk... Enheten starter opp i denne frimodusen hvis enheten startes opp mens du sitter.</p> <p>Mens enheten er i sittmodus, registrerer den bevegelsen når du begynner å reise deg, og låser mot fleksjon idet du reiser deg slik at du ikke kan sette deg ned igjen enten før benet er helt utstrukket eller du trykker på overstyringsknappen.</p>
Sittende til gående 		<p>Når enheten er i sittmodus, registrerer enheten bevegelsen når du reiser deg og begynner å gå, og bytter automatisk til gåmodus.</p> <p>Når du skal reise deg, plasserer du føttene jevnt, bøyer overkroppen fremover og støtter deg med armene idet du reiser deg. Prøv å legge vekt på ortosen, og begynn å gå.</p> <p> Hvis du ikke fullfører bevegelsen og forsøker å sette deg ned igjen, låses enheten mot fleksjon.</p>
Gå opp trapper 		<p> For sikkerhetens skyld må du bytte manuelt til låsmodus før du begynner å gå opp trapper.</p> <p> Brukeren må alltid støtte seg på rekkverk om mulig.</p> <p>Når låsmodus brukes, gir ikke kneet etter (men det kan strekke seg ut), så du må bruke en «sett foten inntil»-bevegelse der du fører med det friske benet når du går opp trappene.</p>

Aktivitet	Modus aktivert og vist	Funksjon og prosedyre
<p>Gå ned trapper</p> 	<p>Trapper</p>  <p>Lås</p> 	<p>⚠ I <i>trappemodus</i> må du ikke forsøke å sette den ene foten foran den andre når du går nedover, før du har fått fysioterapi og gått gjennom opplæring som er overvåket og godkjent av legen.</p> <p>⚠ Vær alltid forsiktig i trapper, og vær oppmerksom på omgivelsene.</p> <p>⚠ Brukeren må alltid støtte seg på rekkverk om mulig.</p> <p>⚠ Når du skal gå ned trapper, må enten <i>trappemodus</i> eller <i>låsemodus</i> aktiveres før du begynner å gå nedover. Når en modus er valgt, må du ikke bytte før du er ferdig med å gå ned trappen.</p> <p><i>Trappemodusen</i> gir god nok støtte til at brukeren kan gå ned trappen med den ene foten foran den andre. Den har programmert fleksjonsmotstand kombinert med passende ekstensjonsforspenning.</p> <p>Merk... Sett kun den bakre halvdel av foten på trinnet. Legg så belastning på ortosen og press den inn i knefleksjon, trå ned med det friske benet og la ortosen flekere i kneet.</p> <p>Når <i>låsemodusen</i> brukes, gir ikke kneet etter. Det er låst i full ekstensjon, så du må bruke en «sett foten inntil»-bevegelse der du fører med den låste protesen når du går ned trappene.</p>
<p>Sette seg inn i kjøretøy</p> 	<p>Sitt</p> 	<p>⚠ Vær alltid forsiktig rundt kjøretøy, og vær oppmerksom på omgivelsene.</p> <p>Aktiver <i>sittemodusen</i> når du skal sette deg inn i et kjøretøy.</p> <p>Enheten bytter til <i>fritilstanden</i> av <i>sittemodusen</i> når låret er horisontalt. (Ikke det samme som <i>frimodusen</i>.) Da kan du manøvrere protesen til en behagelig og trygg posisjon.</p> <p>Merk... Hvis lårets vinkel ikke er horisontal, f.eks. på grunn av vinkelen på setet, bytter enheten til <i>sitt til stå-tilstanden</i> av <i>sittemodusen</i> og kan kun posisjoneres ved bruk av den mekaniske overstyringsknappen.</p>
<p>Gå ut av kjøretøy</p> 	<p>Sitt</p> 	<p>Før du stiger ut av et kjøretøy, må du passe på at enheten er i <i>sittmodus</i> slik at du støttes idet du går fra sittende til stående når du stiger ut. Enheten er klar til å bytte automatisk til <i>gåmodus</i>.</p>

Aktivitet	Modus aktivert og vist	Funksjon og prosedyre
<p>Kjøring</p> 	<p><i>Fri</i></p> 	<p> Du må ikke bruke kontrollknappene eller fjernkontrollen til enheten mens du kjører.</p> <p> Advarselen i dette dokumentet og eventuelle nasjonale forskrifter må følges hvis brukeren tenker å kjøre mens hen har på seg en Tectus KAFO.</p> <p> Kun det friske benet skal brukes til å kjøre bil. Når du skal kjøre, må du bytte manuelt til <i>frimodus</i> med fjernkontrollen eller kontrollknappene.</p>
<p>Sikkerhetsmodus</p>		<p>Enheden går tilbake til <i>sikkerhetsmodus</i> hver gang den oppdager feil eller kritisk lavt batterinivå, eller hvis advarselen om vedlikehold er utløpt. I <i>sikkerhetsmodus</i> bytter enheten til høy knefleksjonsmotstand.</p>
<p>Kritisk vedlikehold</p>		<p>Du finner mer informasjon i avsnitt 5.1 <i>Varsel om kritisk vedlikehold</i> og avsnitt 7.3.2 <i>Atferd ved lavt batterinivå</i>.</p>
<p>Opplæring</p>	<p><i>Opplæring</i></p>	<p>Merk... Det er kun legen som kan slå på opplæringsmodusen via appen.</p> <p>I <i>opplæringsmodus</i> avgir enheten lyder og vibrasjoner for å fortelle deg når driftstilstanden i <i>gåmodus</i> endrer seg. Dette er for å hjelpe deg med å lære hvordan du bruker enheten. For eksempel: Når du tar et steg bakover fra stillestående for å aktivere <i>Gå bakover</i>-tilstanden, avgir enheten et langt pip og vibrerer for å bekrefte at <i>Gå bakover</i>-tilstanden er valgt. Når du stopper etter å ha gått, avgir enheten to korte pip og vibrerer for å bekrefte at <i>låsemodus</i> er valgt.</p>









10.4 Handlinger og enhetsindikasjoner

Bruk av enheten og fjernkontrollknappene

Enheden betjenes manuelt enten med A- og B-knappene på enheten eller med knappene på fjernkontrollen. Knappen/knappene som trykkes, samt hvor lenge de holdes inne (kort trykk, langt trykk, svært langt trykk) bestemmer handlingen som velges.









Merk... Knappene på fjernkontrollen har kun to alternativer: kort eller langt trykk.

Enheden avgir et unikt mønster av pip og vibrasjoner for hver av de tre varighetene og viser et ikon på skjermen som forklart i denne tabellen:

Navn	Varighet	Pip med vibrasjoner	Ikon på skjermen	Symbol som brukes i dokumentet
Kort trykk	Maks. 2 sekunder			
Langt trykk	2–4 sekunder			
Svært langt trykk	Lenger enn 4 sekunder			

































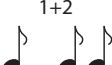
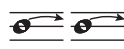

Enhetsindikasjoner

Enheden sier i fra om at den forespurte handlingen, f.eks. modusbytte, er registrert, ved å avgi lyd- og/eller vibrasjonssignaler som vist i denne tabellen:

Type indikasjon	Symbol som brukes i dokumentet	
	Kort	Lang
Lyd (pip)	Høy tone 	
	Middels tone 	
	Lav tone 	
Vibrasjon		
På skjermen	Du finner en detaljert beskrivelse i avsnitt 10.3, 10.5 og 10.6.	
LED-lys på AV/PÅ-knappen	Du finner en detaljert beskrivelse i avsnitt 9.	

10.5 Modusbytte på enheten med A- og B-knappene på Tectus-modulen

Når oppstartssekvensen er ferdig, kan enheten styres med knappkombinasjoner på Tectus-knemodulen eller fjernkontrollen.

Moduser	Aktivering (på enheten)	Tidssignaler		Enhets respons		
		På skjermen	Pip og vibrasjon	Pip	Vibrasjon	Symbol
<i>Gå</i>	Trykk kort på A-knappen 		1 	2 × korte, lave toner 	2 × korte 	
<i>Sitt</i>	Trykk lenge på B-knappen 		1+2 	1 × kort, middels tone 	1 × kort 	
<i>Trapper</i>	Trykk kort på B-knappen 		1 	2 × korte, middels toner 	2 × korte 	
<i>Fri</i>	Trykk kort på A- og B-knappen 		1 	1 × lang, middels tone 	1 × lang 	
<i>Lås</i>	Trykk lenge på A-knappen 		1+2 	2 × lange, middels toner 	2 × lange 	
<i>Stille</i>	Trykk svært lenge på A-knappen 		1+2+3 	2 × korte, middels toner 	2 × korte 	

Merk... Ikke hold inne B-knappen i mer enn fire sekunder. Da slås **Bluetooth**® på. Dette vises ved at av/på-knappen blinker blått og lyser solid grønt og avgir tre lave toner og vibrasjoner. Dette er ikke en brukerfunksjon, så den må være av. For å slå den av må du slå av og så på igjen enheten med AV/PÅ-knappen (se avsnitt 9) eller holde inne B-knappen i mer enn fire sekunder.



10.6 Modusbytte på enheten med fjernkontrollen

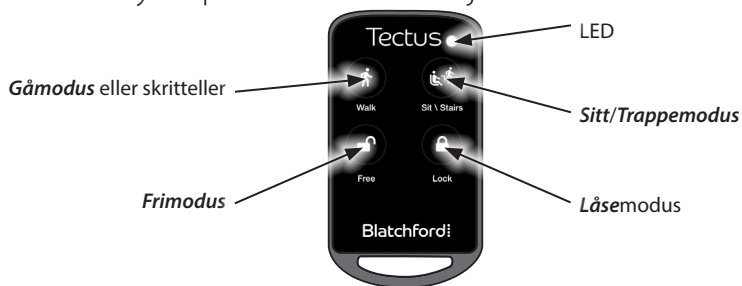

Moduser	Aktivering (på fjernkontrollen)	Tidssignaler		Enhets respons		
		På skjermen	Pip og vibrasjon	Pip	Vibrasjon	Symbol
<i>Gå</i>	Trykk kort på Gå-knappen			2 x korte, lave toner	2 x korte	
<i>Sitt</i>	Trykk kort på Sitt/Trapperknappen			1 x kort, middels tone	1 x kort	
<i>Trapper</i>	Trykk lenge på Sitt/Trapperknappen			2 x korte, middels toner	2 x korte	
<i>Fri</i>	Trykk kort på Fri-knappen			1 x lang, middels tone	1 x lang	
<i>Lås</i>	Trykk kort på Lås-knappen			2 x korte, middels toner	2 x korte	

10.7 Flere fjernkontrollfunksjoner

Moduser	Aktivering (på fjernkontrollen)	Tidssignaler		Enhets respons		
		På skjermen	Pip og vibrasjon	Pip	Vibrasjon	Symbol
Skritteller	Trykk lenge på Gå-knappen			-	-	
Tilkoblingskode	Trykk lenge på Lås-knappen			-	-	

10.8 Mekanisk overstyring

Kneet kan flekteres i alle moduser ved å trykke på den manuelle overstyringsknappen øverst på kontrollmodulen. Knappen må holdes inne helt til ønsket knefleksjonsvinkel er nådd.



Ikke bruk gjenstander som skrutrekkere og pinner til å trykke inn overstyringsknappen.



Denne funksjonen skal kun brukes i spesielle tilfeller (f.eks. ved feil eller tomt batteri).

Når overstyringsknappen slippes, går knefleksjonen tilbake til samme motstand som den hadde før brukeren trykket på knappen.

Merk... Den hydrauliske modulen er laget for å alltid tillate fri ekstensjon av benet.



Pass alltid på så fingrene ikke kommer i klem.

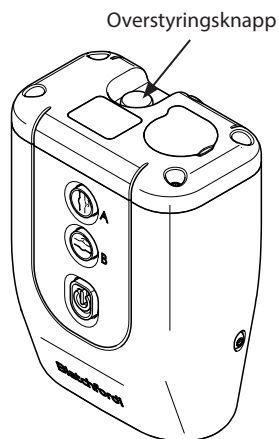

11 Transport og oppbevaring

1. Vi anbefaler å oppbevare enheten stående og i **låsemodus**.
2. Hvis Tectus KAFO-en skal oppbevares stående, må den sikres slik at den ikke faller.
3. Hvis enheten sendes enten alene eller bygd inn i en Tectus KAFO, må den settes i **låsemodus** i utstrakt posisjon og pakkes i en egnet eske.
4. Hvis enheten må sendes tilbake, må du ta kontakt med Blatchford før du sender den hvis det er åpenbare fysiske skader på batteripakken.
5. Enheten må være av og forsvarlig pakket under transport slik at
 - a) den ikke kan bli slått på utilsiktet
 - b) Tectus KAFO / enheten er godt beskyttet mot skade

FCC Compliance Statement



This device complies with part 15 of the FCC Rules.

Operation is subject to the following two conditions:

1. This device may not cause harmful interference.
2. This device must accept any interference received, including interference that may cause undesired operation.

Note... Contains pre-approved **Bluetooth**® module: FCC ID: QOO-GM220P IC: BGM220PC22HNA2.

This equipment has been tested and found to comply with the limits for a Class B digital device, pursuant to part 15 of the FCC Rules. These limits are designed to provide reasonable protection against harmful interference in a residential installation. This equipment generates uses and can radiate radio frequency energy and, if not installed and used in accordance with the instructions, may cause harmful interference to radio communications. However, there is no guarantee that interference will not occur in a particular installation. If this equipment does cause harmful interference to radio or television reception, which can be determined by turning the equipment off and on, the user is encouraged to try to correct the interference by one or more of the following measures:

- Reorient or relocate the receiving antenna.
- Increase the separation between the equipment and receiver.
- Connect the equipment into an outlet on a circuit different from that to which the receiver is connected.
- Consult the dealer or an experienced radio/ TV technician for help.

Any changes or modifications not expressly approved by the party responsible for compliance could void the user's authority to operate the equipment.

Caution: Exposure to Radio Frequency Radiation. This device must not be co-located or operating in conjunction with any other antenna or transmitter.

Responsible party: Blatchford Inc.

1031 Byers Road, Miamisburg, OH 45342
800-548-3534 (toll free) | 937-291-3636
customerservice@blatchfordus.com

RSS Compliance Statement

This device complies with RSS 210 of Industry Canada.

Operation is subject to the following two conditions:

1. this device may not cause interference, and
2. this device must accept any interference, including interference that may cause undesired operation of this device.

L' utilisation de ce dispositif est autorisée seulement aux conditions suivantes:

1. il ne doit pas produire d'interférence et
2. l' utilisateur du dispositif doit être prêt à accepter toute interférence radioélectrique reçue, même si celle-ci est susceptible de compromettre le fonctionnement du dispositif.

Caution: Exposure to Radio Frequency Radiation.

The installer of this radio equipment must ensure that the antenna is located or pointed such that it does not emit RF field in excess of Health Canada limits for the general population; consult Safety Code 6, obtainable from Health Canada's website Blatchford Inc. 1031 Byers Road, Miamisburg, OH 45342.

800-548-3534 (toll free) | 937-291-3636 customerservice@blatchfordus.com

Erstatningsansvar

Produsenten anbefaler å bruke enheten kun under de angitte forholdene og til de tiltenkte formålene. Enheten må vedlikeholdes i henhold til bruksanvisningen som følger med enheten. Produsenten er ikke erstatningsansvarlig for skader forårsaket av delekombinasjoner som ikke er autorisert av dem.

CE-samsvar

Dette produktet oppfyller kravene i EU-forordningen 2017/745 om medisinsk utstyr. Dette produktet er klassifisert som en klasse I-enhet i henhold til klassifiseringsreglene beskrevet i vedlegg VIII til forskriften. EU-samsvarserklæringen er tilgjengelig på følgende nettside: www.blatchford.co.uk



Medisinsk enhet



Til flerbruk av én pasient

Garanti

Denne enheten har en garanti på 36 måneder.

Enheten skal inspiseres etter 2 uker, 3 måneder, 6 måneder, 12 måneder og 24 måneder.

Brukeren må være klar over at endringer eller modifikasjoner som ikke uttrykkelig er godkjent, kan annullere garantien, driftslisensene og unntakene.

Det ovennevnte kan variere fra marked til marked. Rådfør deg med din lokale representant for flere detaljer.

Se nettstedet til Blatchford for gjeldende full garantierklæring.

Rapportering av alvorlige hendelser

Hvis det mot formodning skulle oppstå en alvorlig hendelse relatert til denne enheten, skal hendelsen rapporteres til produsenten og den relevante myndigheten i landet ditt.

Miljøhensyn



Dette symbolet angir at produktet inneholder elektriske/elektroniske komponenter og/eller batterier som ikke skal kastes i restavfall eller brennes på slutten av levetiden.

På slutten av produktets levetid skal alle elektriske/elektroniske komponenter og/eller batterier resirkuleres eller avhendes i henhold til gjeldende lovverk for håndtering av WEEE (avfall fra elektrisk og elektronisk utstyr), eller tilsvarende lokale forskrifter. Det som er igjen av produktet skal også resirkuleres hvis det er mulig i samsvar med lokale forskrifter for avfallshåndtering.

Blatchford tilbyr en returtjeneste for å forhindre potensiell skade på miljøet eller menneskers helse grunnet ukontrollert avfallshåndtering. Ta kontakt med kundeservice for detaljer.

Varemerkeanerkjennelser

Tectus og Blatchford er registrerte varemerker som tilhører Blatchford Products Limited.

Bluetooth®-ordmerket og -logoene er registrerte varemerker som eies av Bluetooth SIG Inc., og Blatchfords bruk av slike merker er underlagt lisensavtale Andre varemerker og varenavn tilhører sine respektive eiere.

Produsentens registrerte adresse

Blatchford Products Limited, Lister Road, Basingstoke RG22 4AH, Storbritannia.



blatchford.co.uk/distributors

Blatchford Products Ltd.

Unit D Antura
Kingsland Business Park
Basingstoke
RG24 8PZ
UNITED KINGDOM
Tel: +44 (0) 1256 316600
Fax: +44 (0) 1256 316710
Email: customer.service@blatchford.co.uk
www.blatchford.co.uk

Blatchford Europe GmbH

Am Prime-Parc 4
65479 Raunheim
GERMANY
Tel: +49 (0) 9221 87808 0
Fax: +49 (0) 9221/87808 60
Email: info@blatchford.de
www.blatchford.de

Email: contact@blatchford.fr
www.blatchford.fr

Blatchford Inc.

1031 Byers Road
Miamisburg
Ohio 45342
USA
Tel: +1 (0) 800 548 3534
Fax: +1 (0) 800 929 3636
Email: info@blatchfordus.com
www.blatchfordus.com

Ortopro AS

Hardangervegen 72
Seksjon 17
5224 Nesttun
NORWAY
Tel: +47 (0) 55 91 88 60
Email: post@ortopro.no
www.ortopro.no



Blatchford Europe GmbH
Am Prime-Parc 4
65479 Raunheim Germany



© Blatchford Products Limited 2023. All rights reserved.
Patent Pending: EP22187950.5

938464/4-1123