

239017

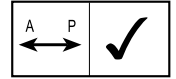

239089

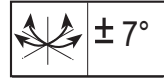
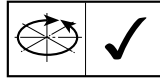
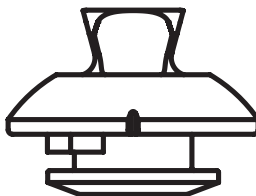
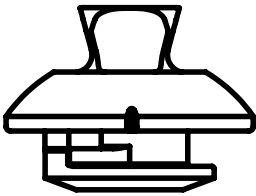
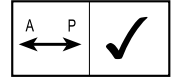

Proximal Pyramid Adapter Kit

Instructions for Use

239017, 239089



Blatchford:

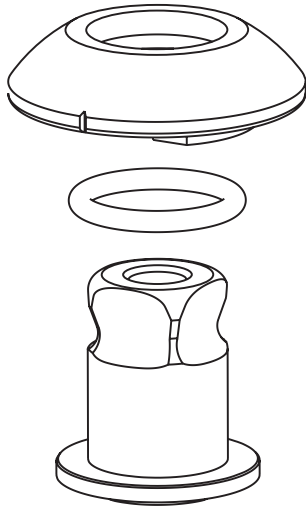

239017

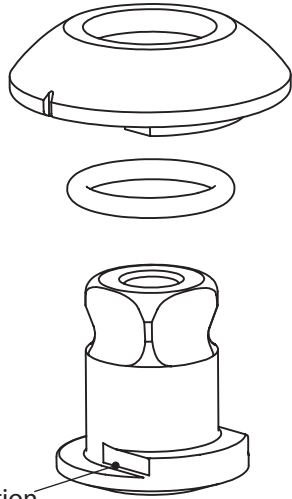

Anti-Rotation
Feature

239089



-
- EN - Fitting Length:
 - FR - Encombrement:
 - DE - Aufbauhöhe:
 - IT - Lunghezza di montaggio:
 - ES - Longitud de ajuste:
 - NO - Monteringslengde:
 - RU - Сборочные размеры:
 - TR - Bağlantı Uzunluğu:

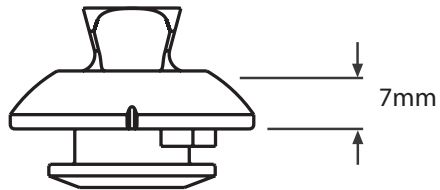

Dynamic Pylon Products

239017

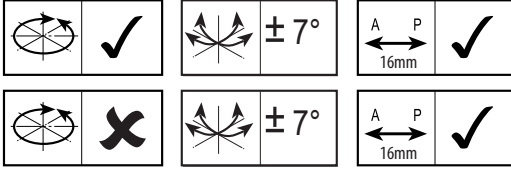

938306

239089

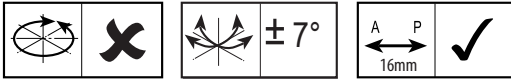

Blatchford:

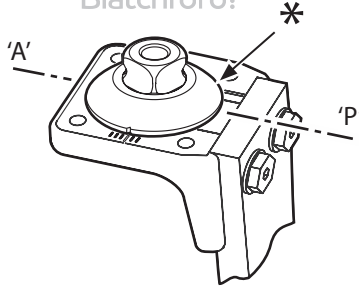

Mercury Knee

239017

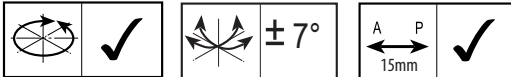

938251

239089

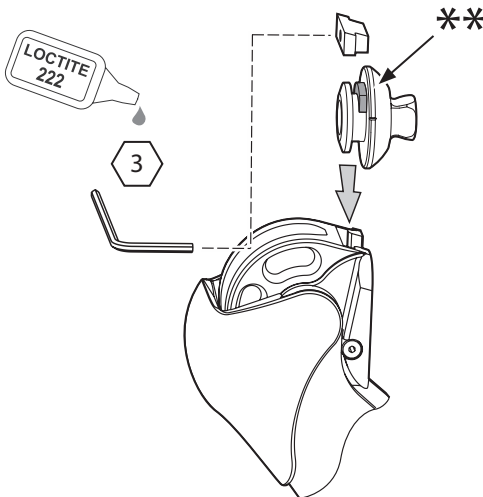
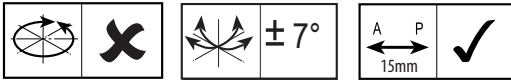

Blatchford:

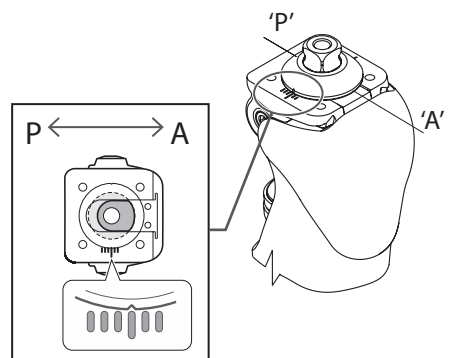

ESK+ 4 Bolt Chassis

239017

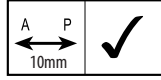
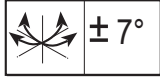

938205

239089

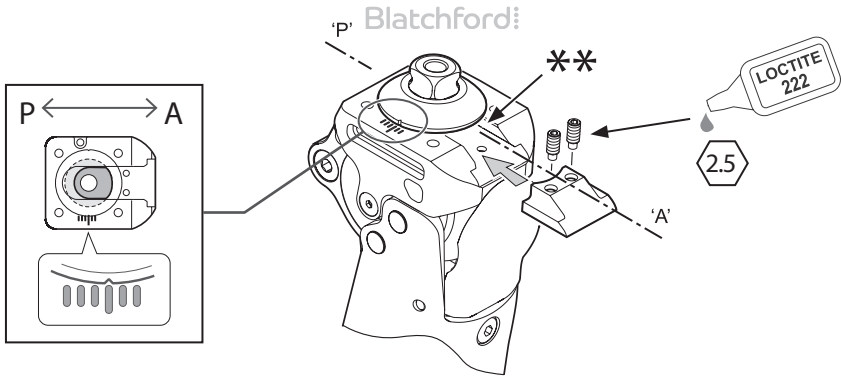
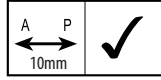
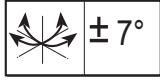

Linx, Orion3

239017

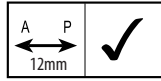
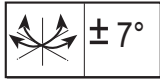

Linx

938353

239089

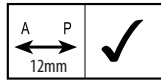
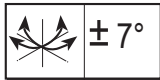

Orion3



938374

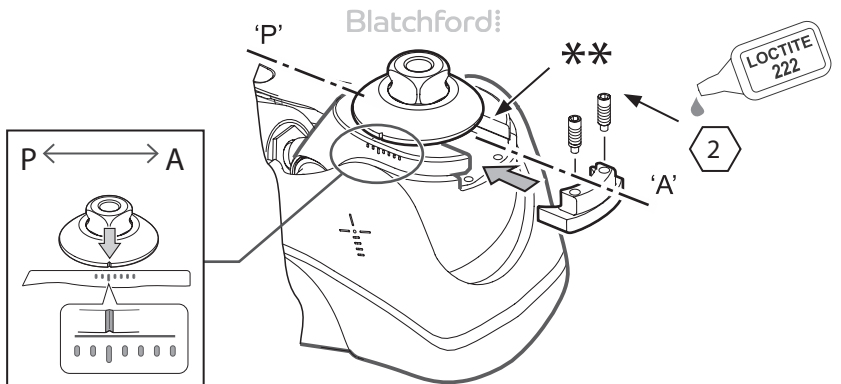

KX06V2

239017

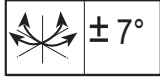

938409

239089

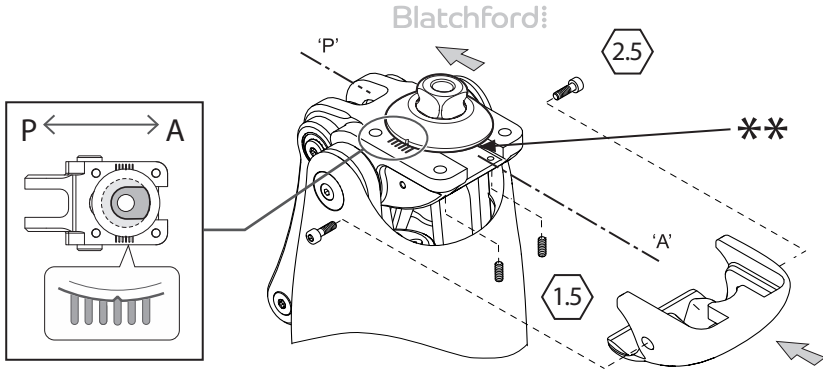
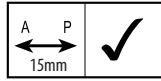
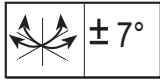

- EN - Anti-rotation feature - Posterior
- FR - Dispositivo Anti-Rotazione - Postérieur
- DE - Anti-Rotationsssicherung - Posterior
- IT - Dispositivo Anti-Rotazione - Posteriore
- ES - Función anti rotatoria - Trasero
- NO - Stopp rotasjon funksjon - Bakre
- RU - Анти функция вращения - задний
- TR - Anti rotasyon özelliği - Posterior

- EN - Anti-rotation feature - Anterior
- FR - Dispositivo Anti-Rotazione - Antérieur
- DE - Anti-Rotationsssicherung - Anterior
- IT - Dispositivo Anti-Rotazione - Anteriore
- ES - Función anti rotatoria - Delantero
- NO - Stopp rotasjon funksjon - Fremre
- RU - Анти функция вращения - передний
- TR - Anti rotasyon özelliği - Anterior

Manufacturer's Registered Address/ Adresse enregistrée du fabricant/ Registrierte Adresse des Herstellers/ Indirizzo registrato dal produttore/ Dirección registrada del fabricante/ Produsentens registrerte adresse/ Зарегистрированный адрес производителя/ Üreticinin Kayıtlı Adresi:

Blatchford Products Limited, Lister Road, Basingstoke RG22 4AH, UK.

Blatchford is a registered trademark of Blatchford Products Limited.
Blatchford est une marque déposée de Blatchford Products Limited.
Blatchford ist eine eingetragene Marke von Blatchford Products Limited.
Blatchford è un marchio registrato di Blatchford Products Limited.
Blatchford es una marca registrada de Blatchford Products Limited.
Blatchford er et registrert varemerke for Blatchford Products Ltd.

Blatchford является зарегистрированным товарным знаком Blatchford Products Ltd.
Blatchford, Blatchford Products Ltd. şirketinin tescilli ticari markasıdır.

blatchford.co.uk/distributors

UK

Blatchford Products Limited
Unit D Antura
Kingsland Business Park
Basingstoke
RG24 8PZ
UNITED KINGDOM
Tel: +44 (0) 1256 316600
Fax: +44 (0) 1256 316710
Email: sales@blatchford.co.uk
www.blatchford.co.uk

North America

Endolite North America
1031 Byers Road
Miamisburg
Ohio 45342
USA
Tel: 800.548.3534
Fax: 800.929.3636
Email: info@endolite.com
www.endolite.com

Germany

Endolite Deutschland GmbH,
Fritz-Hornschuch-Str. 9 (3.OG)
D-95326 Kulmbach
Tel: +49 (0) 9221/87808-0
Fax: +49 (0) 9221/87808-60
Email: info@endolite.de
www.endolite.de

France

Endolite France
Parc d'Activités de l'Aéroport
125 Impasse
Jean-Baptiste Say
34470 PEROLS
FRANCE
Tel: +33 (0) 467 820 820
Fax: +33 (0) 467 073 630
Email: contact@endolite.fr
www.endolite.fr

India

Endolite India Ltd
A4 Naraina Industrial Area
Phase - 1
New Delhi
INDIA - 110028
Tel: +91 (011) 45689955
Fax: +91 (011) 25891543
Email: endolite@vsnl.com
www.endoliteindia.com

Norway

Ortopro AS
Hardangervegen 72
seksjon 17
5224 Nesttun
NORWAY
Tel: +47 (0) 55918860
Email: post@ortopro.no
www.ortopro.no